

MSCAN Block Guide V02.14

Original Release Date: 19 MAY 1998
Revised: 18 SEP 2002

Motorola, Inc.

Motorola reserves the right to make changes without further notice to any products herein. Motorola makes no warranty, representation or guarantee regarding the suitability of its products for any particular purpose, nor does Motorola assume any liability arising out of the application or use of any product or circuit, and specifically disclaims any and all liability, including without limitation consequential or incidental damages. "Typical" parameters which may be provided in Motorola data sheets and/or specifications can and do vary in different applications and actual performance may vary over time. All operating parameters, including "Typicals" must be validated for each customer application by customer's technical experts. Motorola does not convey any license under its patent rights nor the rights of others. Motorola products are not designed, intended, or authorized for use as components in systems intended for surgical implant into the body, or other applications intended to support or sustain life, or for any other application in which the failure of the Motorola product could create a situation where personal injury or death may occur. Should Buyer purchase or use Motorola products for any such unintended or unauthorized application, Buyer shall indemnify and hold Motorola and its officers, employees, subsidiaries, affiliates, and distributors harmless against all claims, costs, damages, and expenses, and reasonable attorney fees arising out of, directly or indirectly, any claim of personal injury or death associated with such unintended or unauthorized use, even if such claim alleges that Motorola was negligent regarding the design or manufacture of the part. Motorola and  are registered trademarks of Motorola, Inc. Motorola, Inc. is an Equal Opportunity/Affirmative Action Employer.

©Motorola, Inc., 2001

Revision History

Version Number	Revision Date	Effective Date	Author	Description of Changes
0.0	5-19-98			<p>Summary of changes:</p> <ul style="list-style-type: none"> - First pass release. - Started from Rev. 0.9 of the MSCAN12_2 spec. Changes include the following: * MSCAN enable (CANE) bit added in CANCTL1 register. * RxCAN, TxCAN pins now available as GPIO on Port CANP0,1 respectively when MSCAN not enabled. * Moved the Port CTL register after the PORT and DDR registers in order to place the PORT and DDR registers on an odd word boundary. * Registers \$__20 - \$__3C are reserved and will read 0's and writes will be unimplemented. * Scan added per the HCS12 DFT document. * Register and bit names updated per the HCS12 Module Requirements document. * Converted spec to new TSCS Spec Template (Rev. 3.3) format, organization, and content. Spec was re-organized and some new sections added. * Separated out customer information into Section 1 and moved all internal only information, i.e. conditional text, into Section 2 per the spec template. * Cosmetic and clarification changes made. * Changes to be less specific to the UDR12 world and more applicable to the CDR12 world. * Eliminated "weasel" words, may and should. * Rev. 0.9 spec tagging kept in tact with new functions tagged with temporary tags ((AT) - Additional Test, (T) - existing Test).
0.1	5-25-98	5-25-98		<p>Summary of changes:</p> <ul style="list-style-type: none"> - Updates per individual spec reviews.
0.2	6-3-98			<p>Summary of changes:</p> <ul style="list-style-type: none"> - Further clarification added in spec per Munich's answers to various questions. - Further updates per individual spec reviews. - Changes from Rev. 0.9 of the MSCAN12_2 spec: * Changed the reset state of CSWAI bit to 0.

MSCAN Block Guide V02.14

Version Number	Revision Date	Effective Date	Author	Description of Changes
1.0	6-10-98	6-10-98		<p>Summary of changes:</p> <ul style="list-style-type: none"> - Further clarification added in spec per Munich's answers to various questions. - Changed the reset state of CANE bit to 0 and made the bit write once in normal modes. - Added CAUTION statement recommending that TxCAN have a pull up either internally or externally when CANE=0 to avoid potential CAN protocol violations. - Added Contents sub-section to Section 1, 2 and Appendix A. - Added variability description and optional signals to multiplex MSCAN test pins with integration dependent pins if associated CANP pins are not bonded out. - Sent this version of spec to Delco for review.
1.1	8-3-98	8-3-98		<p>Summary of changes:</p> <ul style="list-style-type: none"> - Reset state of CANIDAR0-7, CANIDMR0-7, CANRXFG, CANTX0, CANTX1, CANTX2, CANRXSHR, CANTXSHR registers changed from 'undefined' to '0' due to synthesizing the REG block of the MSCAN rather than doing it in full custom logic. - Updates per review of spec with Munich design. No functional changes were made, only changes for further clarification. Some spec tags were also updated based on the review of the spec. - Updated I/O signal names in Section 2 of spec per latest HCS12 information. - Added CANCLK frequency to the Engineering Electrical Specs table in Section 2 and to the Maximum Ratings table in Appendix A. - Added MSCAN Bit Transfer Rate table and modified MSCAN Time Quanta Clock Frequency table in Appendix A.

MSCAN Block Guide V02.14

Version Number	Revision Date	Effective Date	Author	Description of Changes
1.2	9-14-98	9-14-98		<p>Summary of changes:</p> <ul style="list-style-type: none"> - Added RXACT flag in CANCTL0 register in bit 6 per the Project Change Request received from the Munich Design Center. This flag will provide an indication that the MSCAN is receiving a message. - Added further clarification on low power options for Run, Wait, and Stop modes. Added description that the MSCAN clocks will shut down if MSCAN is disabled. Also added description regarding the disabling of input hysteresis in Wait & Stop modes. - Clarified recovery from STOP or WAIT functionality. The MSCAN can wake the MCU up out of either STOP or WAIT via the wake-up interrupt if SLPK=1. - Added note regarding interrupt request clearing behavior--will be delayed one cycle once flag is cleared. - Added further clarification on write conditions for CANIDAC and CANTEST registers. - Added additional Warning for the receive & transmit error counter registers. May read an incorrect value if registers are read in any other mode other than sleep or soft reset and for MCUs with dual CPUs, may also cause a CPU fault condition to occur. - Added additional Warning for reading the receive buffer registers. For MCUs with dual CPUs, may cause a CPU fault condition to occur if the receive buffers are read while the RXF flag is cleared. - Corrected the RDPKAN bit description. Reduced drive is not selectable for the TxCAN and RxCAN pins if the MSCAN is enabled. - Added further clarification on CANPORT and CANDDR reads/writes of CANP1-0 when the MSCAN is enabled. - Enabled the pullups out of reset for the entire CAN port (PUPCANE=1 out of reset). Removed cautions regarding the need to have an external pullup on TxCAN to avoid CAN protocol violations. Added further explanations regarding the protection mechanism against violating the CAN protocol (pullups enabled and CANE write once in normal modes). - Removed scan information in DFT section in Section 2. Added that all clocks will be stopped when MCU is in scan mode. - Updated I/O signal list in Section 2. - Updated module variability section in Section 2. - Changed mscanclke signal in module variability section. Will not leave unconnected if MCU does not have an SCG module, but will use in the oscillator to enable the mscanclke. - Added REGWRT bit to CANTEST register. Bit used to enable CPU write access to the test registers. Added bit and write descriptions. Modified RAMBO bit description. - Updated test register read/write condition in Section 2. - Added Port CANP pin connections table in Section 2. - Changed minimum bit transfer rate from dc to 10KBps in Appendix A, AC Electrical Characteristics section. - Updated/added spec tags.

MSCAN Block Guide V02.14

Version Number	Revision Date	Effective Date	Author	Description of Changes
1.3	10-05-98	10-05-98		<p>Summary of Changes:</p> <ul style="list-style-type: none"> - Added bus activity flag for Volvo, RXFRM in CANCTL0 register in bit 7 per the Project Change Request received from the Munich Design Center. This flag will provide an indication that the MSCAN has received a valid message correctly. - Added further clarification on how to program the CANIDMRx registers when receiving standard identifiers. - Updated CANPORT and CANDDR read/write conditions per Architectural Definition review #3. - Changed timer channel references from channel m to channel x to be consistent with signal name used in RTL. - Spec tags updated per MSCAN requirements. - Corrected write descriptions for CANCRCH/L, CANRXSHR, CANRXSHR registers in Section 2. - Updated MSCAN clock enable module variations in Section 2. - Corrected spelling errors.
1.4	11-15-98	11-15-98		<p>Summary of Changes:</p> <ul style="list-style-type: none"> - In register map, changed CANRXFG (foreground receive buffers) to indicate write is unimplemented. - Changed REGWRT bit name to ECLOAD since bit is now used to load only the error counters with test data. Also changed the write conditions for this bit. It is no longer required for SFTRES to be set to write to ECLOAD. - Changed the implementation for loading the error counters with a test value. Updated ECLOAD per the new implementation. Also added a description in CANRXERR and CANTXERR of how to load the error counters with a desired value in test mode. - Updated max System and MSCAN clock frequency's per decision to design all modules to 16MHz max. - Changed vsc_smod_t4 to vsc_smod_t2 per smod timing change request. - Added footnote for TWUP parameter in Appendix A. - Corrected Port CANP data out signal names in Table 2-4. - Update module I/O list in Section 2.
1.5	12-4-98	12-4-98		<p>Summary of Changes:</p> <ul style="list-style-type: none"> - Added clarification for RXFRM and RXACT behaviour in loop back mode. - Corrected format for CANRXERR and CANTXERR register write descriptions in Section 2.
1.6	1-10-99	1-10-99		<p>Summary of Changes:</p> <ul style="list-style-type: none"> - Added CAUTION to CANDDR register description. Need to wait one cycle before reading the CANPORT register after writing to the CANDDR register when DDR changed to inputs.
1.7	3-9-99	3-9-99		<p>Summary of Changes:</p> <ul style="list-style-type: none"> - Clarified Receive/Transmit buffer read/write capability. - Updated Table 2-5 Engineering Electrical Specs min VDD from 2.7V to 3.0V.

MSCAN Block Guide V02.14

Version Number	Revision Date	Effective Date	Author	Description of Changes
2.0	8-24-99	8-24-99		<p>Summary of Changes:</p> <ul style="list-style-type: none"> - The required address space is reduced to 64 byte. The former MSCAN was a bit generous with the address map eating up 128byte per each module. By cutting it back it is possible to gain flexibility adding more CAN modules etc. In addition the transmit buffers are mapped to a transmit buffer window in address space. By having this window approach for the transmit buffer it is possible to seamless scale the number of transmit buffers up to 8 (although this is NOT planned yet). This requires also separate registers for ABORT-Request and Abort-Acknowledge. In general this split eases the software and should not have an impact to those not using the abort feature. It is also possible to simplify and speed up the software addressing those buffers by using the TXWIN register. It is not necessary to search for an empty buffer anymore. Also the destination address is logically the same which is very helpful when writing HC08 code (more than for HC12), since the HC08 has severe limitations with the one index register. - The port interface is removed. The functionality will be provided by a separate external module. This will be generic to the HCS12 family, since for higher reuse efficiency want to separate the module functionality (e.g. CAN) from the chip dependant implementation (e.g. TXCAN signal tied to Port Module PCAN) - Full DFT compliant implementation (allows automatic scan chain insertion) - 4 message buffers within the receiver FIFO (instead of 2 in former designs). This was a strong request from the field and customers to improve the interrupt latency, while keeping the programmers model. - Enhanced clocking and reset strategy. The number of internal clocks was reduced to two clocks. The time quanta clock, the Rx-Bit clock and the pipelined clock pulses of the CAN clock domain are substituted by the internal CAN clock and a set of special clock enable signals which provide the same timing behavior for the MSCAN. All flip-flops in the design are asynchronously reset using the IPbus hard_rst_b signal. - MSRS compliant IPbus interface substitutes the former HCS12 bus interface. - The actual flags for warning and error are LEVEL sensitive, which is a bit tricky to handle in software. The actual change provides a interrupt-on-status-change for warning, and error level, as well as an indication of the actual status. The BUSOFF bit has not been changed. -New Listen-Only Mode, which allows the MSCAN to monitor the CAN bus without generating acknowledges or error-frames by such a receive. In addition the error counters are not affected. - Soft Reset Mode was changed to Initialization Mode. Due to a strict 2 clock -D-Flipflop strategy a minor change in the form known as SLPRQ was introduced. It is now a clear handshake request-acknowledge. Impact is actually minor, since the handshake process is a matter of some clocks and is only of real importance if a very slow CAN clock in the range of 10kBits is used. - Updated Table 2-2 Engineering Electrical Specs - Updated Table 2-1 MSCAN Module I/O Signals - Updated Register Map (check Figure 1-3)

MSCAN Block Guide V02.14

Version Number	Revision Date	Effective Date	Author	Description of Changes
2.01	18-01-00	18-01-00		Summary of Changes: - When Listen-Mode is active the TXEx flags in the CANTFLG register cannot be cleared and no CAN message is transmitted. - In special test mode the RxBuffers are read/writable from the IPbus side.
2.02	03-02-00	03-02-00		Summary of Changes: - Updated Spec. Tagging - Reserved bits/bytes within Tx-/Rx-Buffer range are read as "x" instead of "0" - Changed reset values for Tx-/Rx-Buffers
2.03	10-07-00	10-07-00		Summary of Changes: - Updated Table 1-9 CPU vs. MSCAN Operating Modes - Corrected typo in INITAK handshake flag (1.7.1.2) - Updated wake-up note for WUPE flag (1.7.1.1)
2.04	21-08-00	21-08-00		Summary of Changes: - Added information on the blocking mechanism for transmit buffers which are scheduled for transmission (TXEx flag cleared) (see 1.7.1.7 & 1.7.1.11). - Added information on the read value ('x') for unused bits in the transmit/receive buffers (see 1.7.2).
2.05	08-11-00	08-11-00		Summary of Changes: - Added 5th Rx Message Buffer to MSCAN.
2.06	20-11-00	20-11-00		- Reformatted MSCAN spec form MMD-format to SRS2.0
V02.07	13 MAR 2001	13 MAR 2001		- Updated according to requirements of SRSv2 supplement.
V02.08	17 JUL 2001	17 JUL 2001		- 1st official version by Technical Publishing
V02.09	10 JUL 2001	10 JUL 2001		- Updated according to requirements of SRSv3 - Corrected footnote 1 in INITRQ description.
V02.10	10 OCT 2001	10 OCT 2001		- Replaced all references w.r.t. new family name HCS12.
V02.11	22 OCT 2001	22 OCT 2001		- Corrected figure title and note of CANTIER. - Corrected local enable register names in table 4-4 'CRG Interrupt Vectors'. - Updated block diagram. - Corrected section 'Description of Interrupt Operation'.
V02.12	04 MAR 2002	04 MAR 2002		- Document format updates.
V02.13	22 JUL 2002	22 JUL 2002		- Corrected TBPR register offset. - Corrected Table 'Message Buffer Organization'. - Corrected SLPRQ bit description. - Corrected MSCAN Sleep Mode description. - Updated WUPE bit description. - Updated Simplified State Transitions figure. - Updated Recovery from STOP or WAIT description and CPU vs. MSCAN Modes table.
V02.14	18 SEP 2002	18 SEP 2002		- Added Initialization/Application information. - Replaced 'MCU' with 'CPU' in several places. - Cleaned up Mode descriptions. - General cleanup.

MSCAN Block Guide V02.14

Table of Contents

Section 1 Introduction

1.1 Overview.....	17
1.2 Features.....	18

Section 2 External Signal Description

2.1 Overview.....	19
2.2 Detailed Signal Description.....	19
2.2.1 RXCAN — CAN Receiver Input Pin.....	19
2.2.2 TXCAN — CAN Transmitter Output Pin.....	19
2.3 CAN System.....	19

Section 3 Memory Map/Register Definition

3.1 Overview.....	21
3.2 Module Memory Map.....	21
3.3 Register Descriptions.....	22
3.3.1 Programmer's Model of Control Registers.....	23
3.3.2 Programmer's Model of Message Storage.....	44

Section 4 Functional Description

4.1 General.....	50
4.2 Message Storage.....	51
4.2.1 Message Transmit Background.....	51
4.2.2 Transmit Structures.....	52
4.2.3 Receive Structures.....	53
4.3 Identifier Acceptance Filter.....	54
4.3.1 Protocol Violation Protection.....	58
4.3.2 Clock System.....	58
4.4 Timer Link.....	61
4.5 Modes of Operation.....	61
4.5.1 Normal Modes.....	61
4.5.2 Special Modes.....	61
4.5.3 Emulation Modes.....	61
4.5.4 Listen-Only Mode.....	61

4.5.5 Security Modes.....	62
4.6 Low Power Options.....	62
4.6.1 CPU Run Mode.....	62
4.6.2 CPU Wait Mode.....	63
4.6.3 CPU Stop Mode.....	63
4.6.4 MSCAN Sleep Mode.....	63
4.6.5 MSCAN Initialization Mode.....	65
4.6.6 MSCAN Power Down Mode.....	66
4.6.7 Programmable Wake-Up Function.....	67
4.7 Reset Initialization.....	67
4.8 General.....	67
4.9 Description of Interrupt Operation.....	68
4.9.1 Transmit Interrupt.....	68
4.9.2 Receive Interrupt.....	68
4.9.3 Wake-Up Interrupt.....	68
4.9.4 Error Interrupt.....	68
4.10 Interrupt Acknowledge.....	68
4.11 Recovery from STOP or WAIT.....	69

Section 5 Initialization/Application Information

5.1 MSCAN initialization.....	69
-------------------------------	----

List of Figures

Figure 1-1	MSCAN Block Diagram	17
Figure 2-1	The CAN System	20
Figure 3-1	MSCAN Control 0 Register (CANCTL0)	23
Figure 3-2	MSCAN Control 1 Register (CANCTL1)	26
Figure 3-3	MSCAN Bus Timing Register 0 (CANBTR0)	27
Figure 3-4	MSCAN Bus Timing Register 1 (CANBTR1)	28
Figure 3-5	MSCAN Receiver Flag Register (CANRFLG)	30
Figure 3-6	MSCAN Receiver Interrupt Enable Register (CANRIER)	32
Figure 3-7	MSCAN Transmitter Flag Register (CANTFLG)	34
Figure 3-8	MSCAN Transmitter Interrupt Enable Register (CANTIER)	35
Figure 3-9	MSCAN Transmitter Message Abort Request (CANTARQ)	35
Figure 3-10	MSCAN Transmitter Message Abort Control (CANTAAC)	36
Figure 3-11	MSCAN Transmitter Flag Register (CANTBSEL)	37
Figure 3-12	MSCAN Identifier Acceptance Control Register (CANIDAC)	38
Figure 3-13	Reserved Registers	39
Figure 3-14	MSCAN Receive Error Counter Register (CANRXERR)	40
Figure 3-15	MSCAN Transmit Error Counter Register (CANTXERR)	40
Figure 3-16	MSCAN Identifier Acceptance Registers (1st Bank)	41
Figure 3-17	MSCAN Identifier Acceptance Registers (2nd Bank)	42
Figure 3-18	MSCAN Identifier Mask Registers (1st Bank)	43
Figure 3-19	MSCAN Identifier Mask Registers (2nd Bank)	43
Figure 3-20	Receive / Transmit Message Buffer Extended Identifier	45
Figure 3-21	Standard Identifier Mapping	46
Figure 3-22	Transmit Buffer Priority Register (TBPR)	49
Figure 3-23	Time Stamp Register (TSRH - High Byte)	49
Figure 3-24	Time Stamp Register (TSRL - Low Byte)	49
Figure 4-1	User Model for Message Buffer Organization	51
Figure 4-2	32-bit Maskable Identifier Acceptance Filter	56
Figure 4-3	16-bit Maskable Identifier Acceptance Filters	56
Figure 4-4	8-bit Maskable Identifier Acceptance Filters	57
Figure 4-5	MSCAN Clocking Scheme	58
Figure 4-6	Segments within the Bit Time	60
Figure 4-7	Sleep Request / Acknowledge Cycle	63

Figure 4-8	Simplified State Transitions for Entering/Leaving Sleep Mode	65
Figure 4-9	Initialization Request/Acknowledge Cycle	66

List of Tables

Table 3-1	MSCAN Register Organization	21
Table 3-2	Module Memory Map	21
Table 3-3	Synchronization Jump Width	28
Table 3-4	Baud Rate Prescaler	28
Table 3-5	Time Segment 2 Values.	29
Table 3-6	Time Segment 1 Values.	30
Table 3-7	Identifier Acceptance Mode Settings	38
Table 3-8	Identifier Acceptance Hit Indication	39
Table 3-9	Message Buffer Organization	45
Table 3-10	Data length codes	48
Table 4-1	Time Segment Syntax	60
Table 4-2	CAN Standard Compliant Bit Time Segment Settings.	61
Table 4-3	CPU vs. MSCAN Operating Modes.	62
Table 4-4	CRG Interrupt Vectors	67

Preface

Terminology

Acronyms and Abbreviations

Acronyms and Abbreviations	
ACK	Acknowledge
CAN	Controller Area Network
CRC	Cyclic Redundancy Code
EOF	End of Frame
FIFO	First-In-First-Out Memory
IFS	Inter-Frame Sequence
MSCAN	Motorola Scalable CAN Module
SOF	Start of Frame

Section 1 Introduction

1.1 Overview

The Motorola Scalable Controller Area Network (MSCAN) definition is based on the MSCAN12 definition which is the specific implementation of the Motorola Scalable CAN concept targeted for the Motorola MC68HC12 Microcontroller Family.

The module is a communication controller implementing the CAN 2.0 A/B protocol as defined in the BOSCH specification dated September 1991. For users to fully understand the MSCAN specification, it is recommended that the Bosch specification be read first to familiarize the reader with the terms and concepts contained within this document.

The CAN protocol was primarily, but not only, designed to be used as a vehicle serial data bus, meeting the specific requirements of this field: real-time processing, reliable operation in the EMI environment of a vehicle, cost-effectiveness and required bandwidth.

MSCAN utilizes an advanced buffer arrangement resulting in a predictable real-time behavior and simplifies the application software.

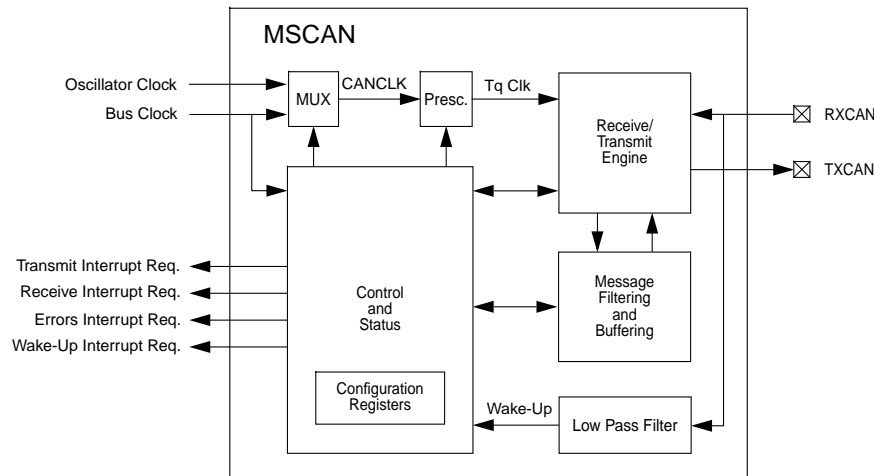

Figure 1-1 MSCAN Block Diagram

1.2 Features

The basic features of the MSCAN are as follows:

- Implementation of the CAN protocol - Version 2.0A/B
 - Standard and extended data frames
 - 0 - 8 bytes data length
 - Programmable bit rate up to 1 Mbps¹
 - Support for remote frames
 - 5 receive buffers with FIFO storage scheme
- 3 transmit buffers with internal prioritization using a “local priority” concept
- Flexible maskable identifier filter supports two full size extended identifier filters (two 32-bit) or four 16-bit filters or eight 8-bit filters
- Programmable wake-up functionality with integrated low-pass filter
- Programmable loop back mode supports self-test operation
- Programmable listen-only mode for monitoring of CAN bus
- Separate signalling and interrupt capabilities for all CAN receiver and transmitter error states (Warning, Error Passive, Bus-Off)
- Programmable MSCAN clock source either Bus Clock or Oscillator Clock
- Internal timer for time-stamping of received and transmitted messages
- Three low power modes: Sleep, Power Down and MSCAN Enable
- Global initialization of configuration registers

NOTES:

1. Depending on the actual bit timing and the clock jitter of the PLL.

Section 2 External Signal Description

2.1 Overview

This section lists and describes the signals that connect off chip.

2.2 Detailed Signal Description

The MSCAN uses two external pins.

2.2.1 RXCAN — CAN Receiver Input Pin

RXCAN is the MSCAN receiver input pin.

2.2.2 TXCAN — CAN Transmitter Output Pin

TXCAN is the MSCAN transmitter output pin. The TXCAN output pin represents the logic level on the CAN bus:

- 0 = Dominant state
- 1 = Recessive state

2.3 CAN System

A typical CAN system with MSCAN is shown in **Figure 2-1**. Each CAN station is connected physically to the CAN bus lines through a transceiver chip. The transceiver is capable of driving the large current needed for the CAN bus and has current protection against defected CAN or defected stations.

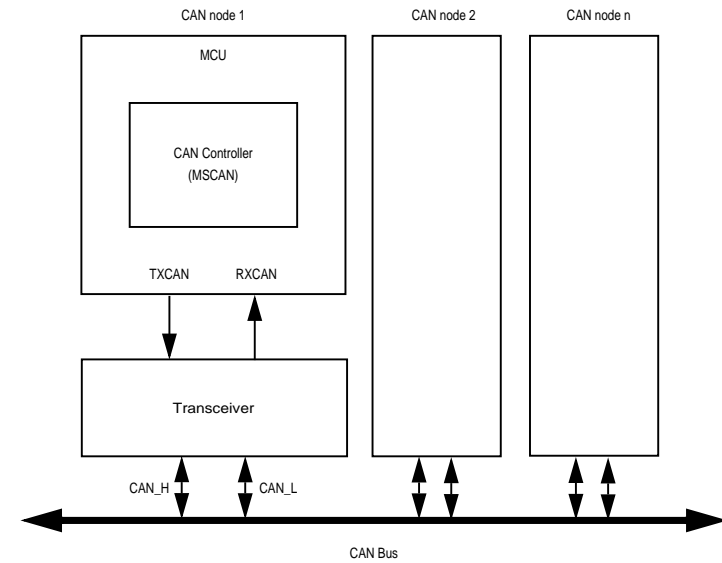

Figure 2-1 The CAN System

Section 3 Memory Map/Register Definition

3.1 Overview

This section provides a detailed description of all registers accessible in the MSCAN.

3.2 Module Memory Map

Table 3-1 and **Table 3-2** give an overview on all registers and their individual bits in the MSCAN memory map. The *register address* results from the addition of *base address* and *address offset*. The *base address* is determined at the MCU level. The *address offset* is defined at the module level.

The MSCAN occupies 64 bytes in the memory space. The base address of the MSCAN module is determined at the MCU level when the MCU is defined. The register decode map is fixed and begins at the first address of the module address offset.

Address Offset	
\$__00	CONTROL REGISTERS 12 BYTES
\$__0B	
\$__0C	RESERVED 2 BYTES
\$__0D	
\$__0E	ERROR COUNTERS 2 BYTES
\$__0F	
\$__10	IDENTIFIER FILTER 16 BYTES
\$__1F	
\$__20	RECEIVE BUFFER 16 BYTES (Window)
\$__2F	
\$__30	TRANSMIT BUFFER 16 BYTES (Window)
\$__3F	

Table 3-1 MSCAN Register Organization

Table 3-1 shows the individual registers associated with the MSCAN and their relative offset from the base address. The detailed register descriptions follow in the order they appear in the register map (see **Table 3-2**).

Table 3-2 Module Memory Map

Address	Use	Access
\$__00	MSCAN Control Register 0 (CANCTL0)	R/W ¹
\$__01	MSCAN Control Register 1 (CANCTL1)	R/W ¹
\$__02	MSCAN Bus Timing Register 0 (CANBTR0)	R/W
\$__03	MSCAN Bus Timing Register 1 (CANBTR1)	R/W

\$__04	MSCAN Receiver Flag Register (CANRFLG)	R/W ¹
\$__05	MSCAN Receiver Interrupt Enable Register (CANRIER)	R/W
\$__06	MSCAN Transmitter Flag Register (CANTFLG)	R/W ¹
\$__07	MSCAN Transmitter Interrupt Enable Register (CANTIER)	R/W ¹
\$__08	MSCAN Transmitter Message Abort Control (CANTARQ)	R/W ¹
\$__09	MSCAN Transmitter Message Abort Control (CANTAACK)	R
\$__0A	MSCAN Transmit Buffer Selection (CANTBSEL)	R/W ¹
\$__0B	MSCAN Identifier Acceptance Control Register (CANIDAC)	R/W ¹
\$__0C -\$__0D	RESERVED	
\$__0E	MSCAN Receive Error Counter Register (CANRXERR)	R
\$__0F	MSCAN Transmit Error Counter Register (CANTXERR)	R
\$__10	MSCAN Identifier Acceptance Register 0 (CANIDAR0)	R/W
\$__11	MSCAN Identifier Acceptance Register 1 (CANIDAR1)	R/W
\$__12	MSCAN Identifier Acceptance Register 2 (CANIDAR2)	R/W
\$__13	MSCAN Identifier Acceptance Register 3 (CANIDAR3)	R/W
\$__14	MSCAN Identifier Mask Register 0 (CANIDMR0)	R/W
\$__15	MSCAN Identifier Mask Register 1 (CANIDMR1)	R/W
\$__16	MSCAN Identifier Mask Register 2 (CANIDMR2)	R/W
\$__17	MSCAN Identifier Mask Register 3 (CANIDMR3)	R/W
\$__18	MSCAN Identifier Acceptance Register 4 (CANIDAR4)	R/W
\$__19	MSCAN Identifier Acceptance Register 5 (CANIDAR5)	R/W
\$__1A	MSCAN Identifier Acceptance Register 6 (CANIDAR6)	R/W
\$__1B	MSCAN Identifier Acceptance Register 7 (CANIDAR7)	R/W
\$__1C	MSCAN Identifier Mask Register 4 (CANIDMR4)	R/W
\$__1D	MSCAN Identifier Mask Register 5 (CANIDMR5)	R/W
\$__1E	MSCAN Identifier 6 Mask Register 6 (CANIDMR6)	R/W
\$__1F	MSCAN Identifier Mask Register 7 (CANIDMR7)	R/W
\$__20 -\$__2F	Foreground Receive Buffer (CANRXFG)	R ²
\$__30 -\$__3F	Foreground Transmit Buffer (CANTXFG)	R ² /W

NOTES:

1. Refer to detailed register description for write access restrictions on per bit basis.
2. Reserved bits and unused bits within the TX- and RX-Buffers (CANTXFG, CANRXFG) will be read as "X", because of RAM based implementation.

3.3 Register Descriptions

This section describes in detail all the registers and register bits in the MSCAN module. Each description includes a standard register diagram with an associated figure number. Details of register bit and field function follow the register diagrams, in bit order. All bits of all registers in this module are completely synchronous to internal clocks during a register read.

3.3.1 Programmer's Model of Control Registers

The programmer's model is laid out for maximum simplicity and efficiency. **Table 3-2** provides an overview of the control registers for the MSCAN.

3.3.1.1 MSCAN Control 0 Register (CANCTL0)

The CANCTL0 register provides for various control of the MSCAN module as described below.

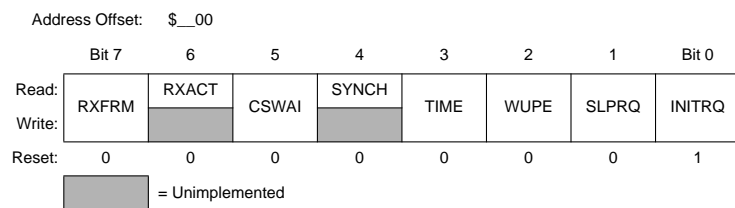

Figure 3-1 MSCAN Control 0 Register (CANCTL0)

NOTE: The CANCTL0 register, except the WUPE, INITRQ and SLPRQ bits, is held in the reset state when the Initialization Mode is active (INITRQ=1 and INITAK=1). This register is writable again as soon as the Initialization Mode is left (INITRQ=0 and INITAK=0).

Read: Anytime

Write: Anytime when out of Initialization Mode; exceptions are read-only bits RXACT and SYNCH, bit RXFRM which is set by the module only and bit INITRQ which is also writable in Initialization Mode.

RXFRM — Received Frame Flag

This bit is read and clear only. It is set when a receiver has received a valid message correctly, independently of the filter configuration. Once set, it remains set until cleared by software or reset. Clearing is done by writing a '1' to the bit. A write '0' is ignored. This bit is not valid in loop back mode.

- 1 = A valid message was received since last clearing of this flag
- 0 = No valid message was received since last clearing this flag.

NOTE: The MSCAN must be in Normal Mode for this bit to become set.

RXACT — Receiver Active Status

This read-only flag indicates the MSCAN is receiving a message. The flag is controlled by the receiver front end. This bit is not valid in loop back mode.

- 1 = MSCAN is receiving a message (including when arbitration is lost)¹
- 0 = MSCAN is transmitting or idle¹.

CSWAI — CAN Stops in Wait Mode

Enabling this bit allows for lower power consumption in Wait Mode by disabling all the clocks at the bus interface to the MSCAN module.

- 1 = The module ceases to be clocked during Wait Mode.
- 0 = The module is not affected during Wait Mode.

NOTE: In order to protect from accidentally violating the CAN protocol the TXCAN pin is immediately forced to a recessive state when the CPU enters Wait (CSWAI=1) or Stop Mode (see 4.6.2 CPU Wait Mode and 4.6.3 CPU Stop Mode)

SYNCH — Synchronized Status

This read-only flag indicates whether the MSCAN is synchronized to the CAN bus and, as such, can participate in the communication process. It is set and cleared by the MSCAN.

- 1 = MSCAN is synchronized to the CAN bus.
- 0 = MSCAN is not synchronized to the CAN bus.

TIME - Timer Enable

This bit activates an internal 16-bit wide free running timer which is clocked by the bit clock. If the timer is enabled, a 16-bit time stamp will be assigned to each transmitted/received message within the active TX/RX buffer. As soon as a message is acknowledged on the CAN bus, the time stamp will be written to the highest bytes (\$_E, \$_F) in the appropriate buffer **3.3.2 Programmer's Model of Message Storage**. The internal timer is reset (all bits set to "0") when Initialization Mode is active.

- 1 = Enable internal MSCAN timer.
- 0 = Disable internal MSCAN timer.

WUPE — Wake-Up Enable

This configuration bit allows the MSCAN to restart from Sleep Mode when traffic on CAN is detected (see 4.6.4 MSCAN Sleep Mode).

- 1 = Wake-Up enabled— The MSCAN is able to restart.
- 0 = Wake-Up disabled— The MSCAN ignores traffic on CAN.

NOTE: The CPU has to make sure that the WUPE register and the WUPIE Wake-Up interrupt enable register **3.3.1.6 MSCAN Receiver Interrupt Enable Register (CANRIER)** is enabled, if the recovery mechanism from STOP or WAIT is required.

SLPRQ — Sleep Mode Request

This bit requests the MSCAN to enter Sleep Mode, which is an internal power saving mode (see 4.6.4 MSCAN Sleep Mode). The Sleep Mode request is serviced when the CAN bus is idle, i.e. the module is not receiving a message and all transmit buffers are empty. The module indicates entry to Sleep Mode by setting SLPK=1 (**3.3.1.2 MSCAN Control 1 Register (CANCTL1)**). Sleep Mode will be active until SLPRQ is cleared by the CPU or, depending on the setting of WUPE bit, the MSCAN detects bus activity on CAN and clears the SLPRQ itself.

NOTES:

1. See the Bosch CAN 2.0A/B protocol specification dated September 1991 for a detailed definition of transmitter and receiver states.

1 = Sleep Mode Request – The MSCAN enters Sleep Mode when CAN bus idle.
 0 = Running – The MSCAN functions normally.

NOTE: The CPU cannot clear the SLPRQ bit before the MSCAN has entered Sleep Mode (SLPRQ=1 and SLPK=1)

INITRQ — Initialization Mode Request

When this bit is set by the CPU, the MSCAN skips to Initialization Mode (see **4.6.5 MSCAN Initialization Mode**). Any ongoing transmission or reception is aborted and synchronization to the bus is lost. The module indicates entry to Initialization Mode by setting INITAK=1 (**3.3.1.2 MSCAN Control 1 Register (CANCTL1)**).

The following registers enter their hard reset state and restore their default values: CANCTL0¹, CANRFLG², CANRIER³, CANTFLG, CANTIER, CANTARQ, CANTAACK, CANTBSEL.

The registers CANCTL1, CANBTR0, CANBTR1, CANIDAC, CANIDAR0-7, CANIDMR0-7 can only be written by the CPU when the MSCAN is in Initialization Mode (INITRQ=1 and INITAK=1). The values of the error counters are not affected by Initialization Mode.

When this bit is cleared by the CPU, the MSCAN restarts and then tries to synchronize to the CAN bus. If the MSCAN is not in Bus-Off state, it synchronizes after 11 consecutive recessive bits on the bus; if the MSCAN is in Bus-Off state it continues to wait for 128 occurrences of 11 consecutive recessive bits.

Writing to other bits in CANCTL0, CANRFLG, CANRIER, CANTFLG or CANTIER must only be done after Initialization Mode is left, which is INITRQ=0 and INITAK=0.

1 = MSCAN in Initialization Mode.
 0 = Normal operation.

NOTE: The CPU cannot clear the INITRQ bit before the MSCAN has entered Initialization Mode (INITRQ=1 and INITAK=1)

NOTE: In order to protect from accidentally violating the CAN protocol the TXCAN pin is immediately forced to a recessive state when the Initialization Mode is requested by the CPU. Thus the recommended procedure is to bring the MSCAN into Sleep Mode (SLPRQ=1 and SLPK=1) before.

3.3.1.2 MSCAN Control 1 Register (CANCTL1)

The CANCTL1 register provides for various control and handshake status information of the MSCAN module as described below.

Address Offset: \$_01

NOTES:

1. Except the WUPE, INITRQ and SLPRQ bits
2. The TSTAT1, TSTAT0 bits are not affected by Initialization Mode
3. The RSTAT1, RSTAT0 bits are not affected by Initialization Mode

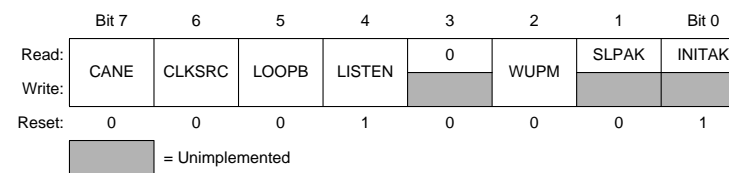

Figure 3-2 MSCAN Control 1 Register (CANCTL1)

Read: Anytime

Write: Anytime when INITRQ=1 and INITAK=1, except CANE which is write once in normal and anytime in special system operation modes when the MSCAN is in Initialization Mode (INITRQ=1 and INITAK=1).

CANE — MSCAN Enable
 1 = The MSCAN module is enabled.
 0 = The MSCAN module is disabled.

CLKSRC — MSCAN Clock Source
 This bit defines the clock source for the MSCAN module (only for systems with a clock generation module; **4.3.2 Clock System** and **Figure 4-5**).
 1 = The MSCAN clock source is the Bus Clock.
 0 = The MSCAN clock source is the Oscillator Clock.

LOOPB — Loop Back Self Test Mode
 When this bit is set, the MSCAN performs an internal loop back which can be used for self test operation. The bit stream output of the transmitter is fed back to the receiver internally. The RXCAN input pin is ignored and the TXCAN output goes to the recessive state (logic '1'). The MSCAN behaves as it does normally when transmitting and treats its own transmitted message as a message received from a remote node. In this state, the MSCAN ignores the bit sent during the ACK slot in the CAN frame Acknowledge field to ensure proper reception of its own message. Both transmit and receive interrupts are generated.
 1 = Loop Back Self Test enabled
 0 = Loop Back Self Test disabled

LISTEN — Listen Only Mode
 This bit configures the MSCAN as a bus monitor. When the bit is set, all valid CAN messages with matching ID are received, but no acknowledgement or error frames are sent out **4.5.4 Listen-Only Mode**. In addition the error counters are frozen.
 Listen Only Mode supports applications which require “hot plugging” or throughput analysis. The MSCAN is unable to transmit any messages, when Listen Only Mode is active.
 1 = Listen Only Mode activated
 0 = Normal operation

WUPM — Wake-Up Mode

This bit defines whether the integrated low-pass filter is applied to protect the MSCAN from spurious wake-up **4.6.4 MSCAN Sleep Mode.**

- 1 = MSCAN wakes-up the CPU only in case of a dominant pulse on the bus which has a length of T_{wup} and WUPE=1 in CANCTL0 (see **3.3.1.1 MSCAN Control 0 Register (CANCTL0)**).
- 0 = MSCAN wakes-up the CPU after any recessive to dominant edge on the CAN bus and WUPE=1 in CANCTL0.

SLPAK — Sleep Mode Acknowledge

This flag indicates whether the MSCAN module has entered Sleep Mode **4.6.4 MSCAN Sleep Mode.** It is used as a handshake flag for the SLPRQ Sleep Mode request. Sleep Mode is active when SLPRQ=1 and SLPAK=1. Depending on the setting of the WUPE bit the MSCAN will clear the flag if it detects bus activity on CAN while in Sleep Mode.

- 1 = Sleep Mode Active – The MSCAN has entered Sleep Mode.
- 0 = Running – The MSCAN operates normally.

INITAK — Initialization Mode Acknowledge

This flag indicates whether the MSCAN module is in Initialization Mode **4.6.5 MSCAN Initialization Mode.** It is used as a handshake flag for the INITRQ Initialization Mode request. Initialization Mode is active when INITRQ=1 and INITAK=1.

The registers CANCTL1, CANBTR0, CANBTR1, CANIDAC, CANIDAR0-7, CANIDMR0-7 can only be written by the CPU when the MSCAN is in Initialization Mode.

- 1 = Initialization Mode Active – The MSCAN has entered Initialization Mode.
- 0 = Running – The MSCAN operates normally.

3.3.1.3 MSCAN Bus Timing Register 0 (CANBTR0)

The CANBTR0 register provides for various bus timing control of the MSCAN module as described below.

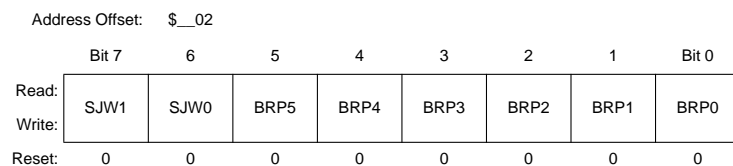

Figure 3-3 MSCAN Bus Timing Register 0 (CANBTR0)

Read: Anytime

Write: Anytime in Initialization Mode (INITRQ=1 and INITAK=1)

SJW1, SJW0 — Synchronization Jump Width

The synchronization jump width defines the maximum number of time quanta (Tq) clock cycles a bit can be shortened or lengthened to achieve resynchronization to data transitions on the bus (see **Table 3-3**).

Table 3-3 Synchronization Jump Width

SJW1	SJW0	Synchronization jump width
0	0	1 Tq clock cycle
0	1	2 Tq clock cycles
1	0	3 Tq clock cycles
1	1	4 Tq clock cycles

BRP[5-0] — Baud Rate Prescaler

These bits determine the time quanta (Tq) clock which is used to build up the individual bit timing, as shown in **Table 3-4**.

Table 3-4 Baud Rate Prescaler

BRP5	BRP4	BRP3	BRP2	BRP1	BRP0	Prescaler value (P)
0	0	0	0	0	0	1
0	0	0	0	0	1	2
0	0	0	0	1	0	3
0	0	0	0	1	1	4
:	:	:	:	:	:	:
1	1	1	1	1	0	63
1	1	1	1	1	1	64

3.3.1.4 MSCAN Bus Timing Register 1 (CANBTR1)

The CANBTR1 register provides for various bus timing control of the MSCAN module as described below.

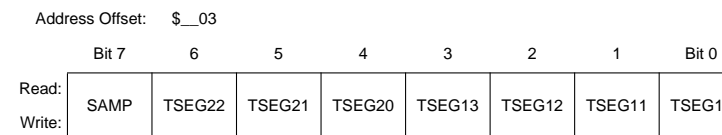

Figure 3-4 MSCAN Bus Timing Register 1 (CANBTR1)

Reset: 0 0 0 0 0 0 0 0

Figure 3-4 MSCAN Bus Timing Register 1 (CANBTR1)

Read: Anytime

Write: Anytime in Initialization Mode (INITRQ=1 and INITAK=1)

SAMP — Sampling

This bit determines the number of samples of the serial bus to be taken per bit time. If set, three samples per bit are taken; the regular one (sample point) and two preceding samples using a majority rule. For higher bit rates, it is recommended that SAMP be cleared which means that only one sample is taken per bit.

- 1 = Three samples per bit¹.
- 0 = One sample per bit.

TSEG22 – TSEG20 — Time Segment 2

Time segments within the bit time fix the number of clock cycles per bit time and the location of the sample point (see **Figure 4-6 Segments within the Bit Time**).

Time segment 2 (TSEG2) values are programmable as shown in **Table 3-5**.

Table 3-5 Time Segment 2 Values

TSEG22	TSEG21	TSEG20	Time segment 2
0	0	0	1 Tq clock cycle ¹
0	0	1	2 Tq clock cycles
.	.	.	.
1	1	0	7 Tq clock cycles
1	1	1	8 Tq clock cycles

NOTES:
 1. This setting is not valid. Please refer to **Table 4-2 CAN Standard Compliant Bit Time Segment Settings** for valid settings.

TSEG13 – TSEG10 — Time Segment 1

Time segments within the bit time fix the number of clock cycles per bit time and the location of the sample point (see **Figure 4-6 Segments within the Bit Time**).

Time segment 1 (TSEG1) values are programmable as shown in **Table 3-6**.

NOTES:
 1. In this case, PHASE_SEG1 must be at least 2 Time Quanta.

Table 3-6 Time Segment 1 Values

TSEG13	TSEG12	TSEG11	TSEG10	Time segment 1
0	0	0	0	1 Tq clock cycle ¹
0	0	0	1	2 Tq clock cycles ¹
0	0	1	0	3 Tq clock cycles ¹
0	0	1	1	4 Tq clock cycles
.
1	1	1	0	15 Tq clock cycles
1	1	1	1	16 Tq clock cycles

NOTES:
 1. This setting is not valid. Please refer to **Table 4-2 CAN Standard Compliant Bit Time Segment Settings** for valid settings.

The bit time is determined by the oscillator frequency, the baud rate prescaler, and the number of time quanta (Tq) clock cycles per bit (as shown in **Table 3-5** and **Table 3-6** above).

$$\text{Bit Time} = \frac{(\text{Prescaler value})}{f_{\text{CANCLK}}} \cdot (\text{number of Time Quanta})$$

3.3.1.5 MSCAN Receiver Flag Register (CANRFLG)

A flag can only be cleared when the condition which caused the setting is no longer valid and can only be cleared by software (writing a '1' to the corresponding bit position). Every flag has an associated interrupt enable bit in the CANRIER register.

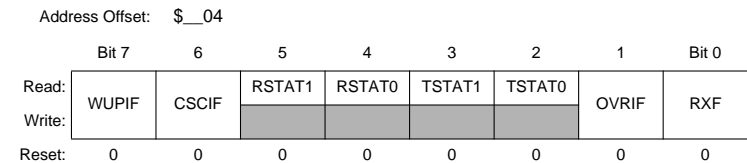

Figure 3-5 MSCAN Receiver Flag Register (CANRFLG)

NOTE: The CANRFLG register is held in the reset state¹ when the Initialization Mode is active (INITRQ=1 and INITAK=1). This register is writable again as soon as the Initialization Mode is left (INITRQ=0 and INITAK=0).

Read: Anytime

Write: Anytime when out of Initialization Mode, except RSTAT[1:0] and TSTAT[1:0] flags which are read-only; write of '1' clears flag; write of '0' ignored

WUPIF — Wake-Up Interrupt Flag

If the MSCAN detects bus activity while in Sleep Mode **4.6.4 MSCAN Sleep Mode** and the WUPE=1 in CANTCTL0 (see **3.3.1.1 MSCAN Control 0 Register (CANCTL0)**), it will set the WUPIF flag. If not masked, a Wake-Up interrupt is pending while this flag is set.

- 1 = MSCAN detected activity on the bus and requested wake-up.
- 0 = No wake-up activity observed while in Sleep Mode.

CSCIF — CAN Status Change Interrupt Flag

This flag is set when the MSCAN changes its current bus status due to the actual value of the Transmit Error Counter (TEC) and the Receive Error Counter (REC). An additional 4-bit (RSTAT[1:0], TSTAT[1:0]) status register, which is split into separate sections for TEC/REC, informs the system on the actual bus status **3.3.1.6 MSCAN Receiver Interrupt Enable Register (CANRIER)**. If not masked, an Error interrupt is pending while this flag is set. CSCIF provides a blocking interrupt. That guarantees that the Receiver / Transmitter status bits (RSTAT/TSTAT) are only updated when no CAN Status Change interrupt is pending. If the TECs/RECs change their current value after the CSCIF is asserted and therefore would cause an additional state change in the RSTAT/TSTAT bits, these bits keep their old state bits until the current CSCIF interrupt is cleared again.

- 1 = MSCAN changed current bus status.
- 0 = No change in bus status occurred since last interrupt.

RSTAT1, RSTAT0 — Receiver Status Bits

The values of the error counters control the actual bus status of the MSCAN. As soon as the Status Change Interrupt Flag (CSCIF) is set these bits indicate the appropriate receiver related bus status of the MSCAN. The coding for the bits RSTAT1, RSTAT0 is:

- 00 = RxOK: 0 ≤ Receive Error Counter ≤ 96
- 01 = RxWRN: 96 < Receive Error Counter ≤ 127
- 10 = RxERR: 127 < Receive Error Counter
- 11 = Bus-Off²: Transmit Error Counter > 255

TSTAT1, TSTAT0 — Transmitter Status Bits

The values of the Error Counters control the actual bus status of the MSCAN. As soon as the Status Change Interrupt Flag (CSCIF) is set these bits indicate the appropriate transmitter related bus status of the MSCAN. The coding for the bits TSTAT1, TSTAT0 is:

NOTES:

1. The RSTAT[1:0], TSTAT[1:0] bits are not affected by Initialization Mode
2. Redundant Information for the most critical bus status which is "CAN Bus-Off". This only occurs if the Tx Error Counter exceeds a number of 255 errors. CAN Bus-Off affects the receiver state. As soon as the transmitter leaves its Bus-Off state the receiver state skips to RxOK too. Refer also to TSTAT[1:0] coding.

- 00 = TxOK: 0 ≤ Transmit Error Counter ≤ 96
- 01 = TxWRN: 96 < Transmit Error Counter ≤ 127
- 10 = TxERR: 127 < Transmit Error Counter ≤ 255
- 11 = Bus-Off: Transmit Error Counter > 255

OVRIF — Overrun Interrupt Flag

This flag is set when a data overrun condition occurs. If not masked, an Error interrupt is pending while this flag is set.

- 1 = A data overrun detected.
- 0 = No data overrun condition.

RXF — Receive Buffer Full Flag

The RXF flag is set by the MSCAN when a new message is shifted in the receiver FIFO. This flag indicates whether the shifted buffer is loaded with a correctly received message (matching identifier, matching Cyclic Redundancy Code (CRC) and no other errors detected). After the CPU has read that message from the RxFG buffer in the receiver FIFO, the RXF flag must be cleared to release the buffer. A set RXF flag prohibits the shifting of the next FIFO entry into the foreground buffer (RxFG). If not masked, a Receive interrupt is pending while this flag is set.

- 1 = The receiver FIFO is not empty. A new message is available in the RxFG.
- 0 = No new message available within the RxFG.

NOTE: To ensure data integrity, do not read the receive buffer registers while the RXF flag is cleared.

For MCUs with dual CPUs, reading the receive buffer registers while the RXF flag is cleared may result in a CPU fault condition.

3.3.1.6 MSCAN Receiver Interrupt Enable Register (CANRIER)

This register contains the interrupt enable bits for the interrupt flags described above.

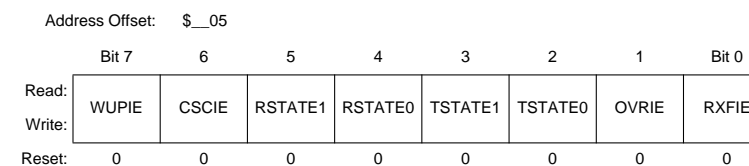

Figure 3-6 MSCAN Receiver Interrupt Enable Register (CANRIER)

NOTE: The CANRIER register is held in the reset state¹ when the Initialization Mode is active (INITRQ=1 and INITAK=1). This register is writable again as soon as the Initialization Mode is left (INITRQ=0 and INITAK=0).

NOTES:

1. The RSTATE[1:0], TSTATE[1:0] bits are not affected by Initialization Mode

Read: Anytime

Write: Anytime when out of Initialization Mode

WUPIE — Wake-Up Interrupt Enable

- 1 = A wake-up event causes a Wake-Up interrupt request.
- 0 = No interrupt request is generated from this event.

NOTE: The CPU has to make sure that the Wake-Up interrupt register and the WUPIE register **3.3.1.1 MSCAN Control 0 Register (CANCTL0)** is enabled, if the recovery mechanism from STOP or WAIT is required.

CSCIE — CAN Status Change Interrupt Enable

- 1 = A CAN Status Change event causes an error interrupt request.
- 0 = No interrupt request is generated from this event.

RSTATE1, RSTATE0— Receiver Status Change Enable

These RSTAT enable bits control the sensitivity level in which receiver state changes are causing CSCIF interrupts. Independent of the chosen sensitivity level the RSTAT flags still indicate the actual receiver state and are only updated if no CSCIF interrupt is pending.

- 11 = generate CSCIF interrupt on all state changes
- 10 = generate CSCIF interrupt only if the receiver enters or leaves “RxErr” or “Bus-Off”¹ state. Discard other receiver state changes for generating CSCIF interrupt.
- 01 = generate CSCIF interrupt only if the receiver enters or leaves “Bus-Off” state. Discard other receiver state changes for generating CSCIF interrupt.
- 00 = do not generate any CSCIF interrupt caused by receiver state changes.

TSTATE1, TSTATE0— Transmitter Status Change Enable

These TSTAT enable bits control the sensitivity level in which transmitter state changes are causing CSCIF interrupts. Independent of the chosen sensitivity level the TSTAT flags still indicate the actual transmitter state and are only updated if no CSCIF interrupt is pending.

- 11 = generate CSCIF interrupt on all state changes
- 10 = generate CSCIF interrupt only if the transmitter enters or leaves “TxErr” or “Bus-Off” state. Discard other transmitter state changes for generating CSCIF interrupt.
- 01 = generate CSCIF interrupt only if the transmitter enters or leaves “Bus-Off” state. Discard other transmitter state changes for generating CSCIF interrupt.
- 00 = do not generate any CSCIF interrupt caused by transmitter state changes.

OVRIE — Overrun Interrupt Enable

- 1 = An overrun event causes an error interrupt request.
- 0 = No interrupt request is generated from this event.

RXFIE — Receiver Full Interrupt Enable

NOTES:

1. Bus-Off state is only defined by the CAN standard for transmitters. Because the only possible state change for the transmitter from Bus-Off to TxOK also forces the receiver to skip its current state to RxOK, the coding of the RXSTAT[1:0] flags define an additional Bus-Off state for the receiver **3.3.1.5 MSCAN Receiver Flag Register (CANRFLG)**

- 1 = A receive buffer full (successful message reception) event causes a receiver interrupt request.
- 0 = No interrupt request is generated from this event.

3.3.1.7 MSCAN Transmitter Flag Register (CANTFLG)

The Transmit Buffer Empty flags each have an associated interrupt enable bit in the CANTIER register.

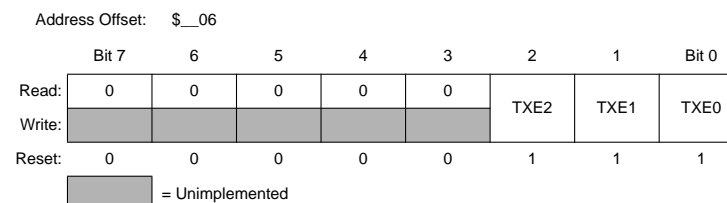

Figure 3-7 MSCAN Transmitter Flag Register (CANTFLG)

NOTE: The CANTFLG register is held in the reset state when the Initialization Mode is active (INITRQ=1 and INITAK=1). This register is writable again as soon as the Initialization Mode is left (INITRQ=0 and INITAK=0).

Read: Anytime

Write: Anytime for TXEx flags when not in Initialization Mode; write of ‘1’ clears flag, write of ‘0’ ignored

TXE2 - TXE0 —Transmitter Buffer Empty

This flag indicates that the associated transmit message buffer is empty, and thus not scheduled for transmission. The CPU must clear the flag after a message is set up in the transmit buffer and is due for transmission. The MSCAN sets the flag after the message is sent successfully. The flag is also set by the MSCAN when the transmission request is successfully aborted due to a pending abort request (see **3.3.1.9 MSCAN Transmitter Message Abort Control (CANTARQ)**). If not masked, a Transmit interrupt is pending while this flag is set.

Clearing a TXEx flag also clears the corresponding ABTAKx (see **3.3.1.10 MSCAN Transmitter Message Abort Control (CANTAACK)**). When a TXEx flag is set, the corresponding ABTRQx bit is cleared (see **3.3.1.9 MSCAN Transmitter Message Abort Control (CANTARQ)**).

When Listen-Mode is active (see **3.3.1.2 MSCAN Control 1 Register (CANCTL1)**) the TXEx flags cannot be cleared and no transmission is started.

Read and write accesses to the transmit buffer will be blocked, if the corresponding TXEx bit is cleared (TXEx=‘0’) and the buffer is scheduled for transmission.

- 1 = The associated message buffer is empty (not scheduled).
- 0 = The associated message buffer is full (loaded with a message due for transmission).

3.3.1.8 MSCAN Transmitter Interrupt Enable Register (CANTIER)

This register contains the interrupt enable bits for the Transmit Buffer Empty interrupt flags.

Address Offset: \$_07

	Bit 7	6	5	4	3	2	1	Bit 0
Read:	0	0	0	0	0	TXEIE2	TXEIE1	TXEIE0
Write:	[Unimplemented]							
Reset:	0	0	0	0	0	0	0	0

[Unimplemented] = Unimplemented

Figure 3-8 MSCAN Transmitter Interrupt Enable Register (CANTIER)

NOTE: The CANTIER register is held in the reset state when the Initialization Mode is active (INITRQ=1 and INITAK=1). This register is writable again as soon as the Initialization Mode is left (INITRQ=0 and INITAK=0).

Read: Anytime

Write: Anytime when not in Initialization Mode

TXEIE2 - TXEIE0 — Transmitter Empty Interrupt Enable

1 = A transmitter empty (transmit buffer available for transmission) event causes a transmitter empty interrupt request.

0 = No interrupt request is generated from this event.

3.3.1.9 MSCAN Transmitter Message Abort Control (CANTARQ)

The CANTARQ register provides for abort request of queued messages as described below.

Address Offset: \$_08

	Bit 7	6	5	4	3	2	1	Bit 0
Read:	0	0	0	0	0	ABTRQ2	ABTRQ1	ABTRQ0
Write:	[Unimplemented]							
Reset:	0	0	0	0	0	0	0	0

[Unimplemented] = Unimplemented

Figure 3-9 MSCAN Transmitter Message Abort Request (CANTARQ)

NOTE: The CANTARQ register is held in the reset state when the Initialization Mode is active (INITRQ=1 and INITAK=1). This register is writable again as soon as the Initialization Mode is left (INITRQ=0 and INITAK=0).

Read: Anytime

Write: Anytime when not in Initialization Mode

ABTRQ2 - ABTRQ0 — Abort Request

The CPU sets the ABTRQx bit to request that a scheduled message buffer (TXEx=0) be aborted. The MSCAN grants the request if the message has not already started transmission, or if the transmission is not successful (lost arbitration or error). When a message is aborted, the associated TXE (see 3.3.1.7 MSCAN Transmitter Flag Register (CANTFLG)) and Abort Acknowledge flags (ABTAK, see 3.3.1.10 MSCAN Transmitter Message Abort Control (CANTAABK)) are set and a transmit interrupt occurs if enabled. The CPU cannot reset ABTRQx. ABTRQx is reset whenever the associated TXE flag is set.

1 = Abort request pending.

0 = No abort request.

3.3.1.10 MSCAN Transmitter Message Abort Control (CANTAABK)

The CANTAABK register indicates the successful abort of a queued message, if requested by the appropriate bits in the CANTARQ register

Address Offset: \$_09

	Bit 7	6	5	4	3	2	1	Bit 0
Read:	0	0	0	0	0	ABTAK2	ABTAK1	ABTAK0
Write:	[Unimplemented]							
Reset:	0	0	0	0	0	0	0	0

[Unimplemented] = Unimplemented

Figure 3-10 MSCAN Transmitter Message Abort Control (CANTAABK)

NOTE: The CANTAABK register is held in the reset state when the Initialization Mode is active (INITRQ=1 and INITAK=1).

Read: Anytime

Write: Unimplemented for ABTAKx flags;

ABTAK2 - ABTAK0 — Abort Acknowledge

This flag acknowledges that a message was aborted due to a pending abort request from the CPU. After a particular message buffer is flagged empty, this flag can be used by the application software to identify whether the message was aborted successfully or was sent anyway. The ABTAKx flag is cleared whenever the corresponding TXE flag is cleared.

1 = The message was aborted.

0 = The message was not aborted.

3.3.1.11 MSCAN Transmit Buffer Selection (CANTBSEL)

The CANTBSEL register allows the selection of the actual transmit message buffer, which will be then accessible in the CANTXFG register space (3.3.1 Programmer's Model of Control Registers).

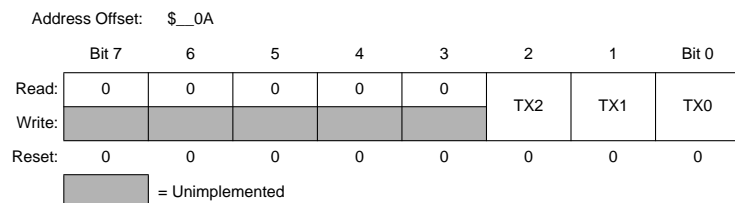

Figure 3-11 MSCAN Transmitter Flag Register (CANTBSEL)

NOTE: The CANTBSEL register is held in the reset state when the Initialization Mode is active (INTRQ=1 and INITAK=1). This register is writable again as soon as the Initialization Mode is left (INTRQ=0 and INITAK=0).

Read: find the lowest ordered bit set to "1", all other bits will be read as "0"

Write: Anytime when not in Initialization Mode

TX2 - TX0 — Transmit Buffer Select

The lowest numbered bit places the respective transmit buffer in the CANTXFG register space (e.g. TX1=1 and TX0=1 selects transmit buffer TX0, TX1=1 and TX0=0 selects transmit buffer TX1)

Read and write accesses to the selected transmit buffer will be blocked, if the corresponding TXEx bit is cleared and the buffer is scheduled for transmission 3.3.1.7 MSCAN Transmitter Flag Register (CANTFLG).

- 1 = The associated message Buffer is selected, if lowest numbered bit.
- 0 = The associated message buffer is deselected

NOTE: The following gives a short programming example of the usage of the CANTBSEL register:

The application software wants to get the next available transmit buffer. It reads the CANTFLG register and writes this value back into the CANTBSEL register. In this example Tx buffers TX1 and TX2 are available. The value read from CANTFLG is therefore 0b0000_0110. When writing this value back to CANTBSEL the Tx buffer TX1 is selected in the CANTXFG because the lowest numbered bit set to "1" is at bit position 1. Reading back this value out of CANTBSEL results in 0b0000_0010, because only the lowest numbered bit position set to "1" is presented. This mechanism eases the application software the selection of the next available Tx buffer.

LDD CANTFLG; value read is 0b0000_0110

STD CANTBSEL; value written is 0b0000_0110

LDD CANTBSEL; value read is 0b0000_0010

If all transmit message buffers are deselected no accesses are allowed to the CANTXFG registers.

3.3.1.12 MSCAN Identifier Acceptance Control Register (CANIDAC)

The CANIDAC register provides for identifier acceptance control as described below.

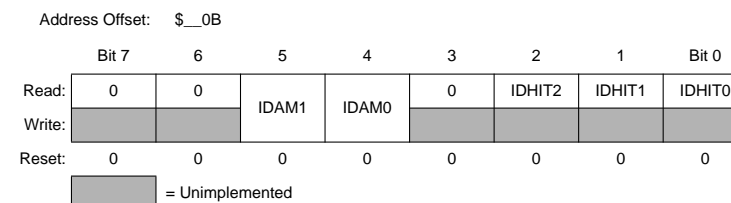

Figure 3-12 MSCAN Identifier Acceptance Control Register (CANIDAC)

Read: Anytime

Write: Anytime in Initialization Mode (INTRQ=1 and INITAK=1), except bits IDHITx which are read-only

IDAM1 - IDAM0 — Identifier Acceptance Mode

The CPU sets these flags to define the identifier acceptance filter organization 4.3 Identifier Acceptance Filter. Table 3-7 summarizes the different settings. In Filter Closed mode, no message is accepted such that the foreground buffer is never reloaded.

Table 3-7 Identifier Acceptance Mode Settings

IDAM1	IDAM0	Identifier Acceptance Mode
0	0	Two 32 bit Acceptance Filters
0	1	Four 16 bit Acceptance Filters
1	0	Eight 8 bit Acceptance Filters
1	1	Filter Closed

IDHIT2 - IDHIT0 — Identifier Acceptance Hit Indicator

The MSCAN sets these flags to indicate an identifier acceptance hit 4.3 Identifier Acceptance Filter. Table 3-8 summarizes the different settings.

Table 3-8 Identifier Acceptance Hit Indication

IDHIT2	IDHIT1	IDHIT0	Identifier Acceptance Hit
0	0	0	Filter 0 Hit
0	0	1	Filter 1 Hit
0	1	0	Filter 2 Hit
0	1	1	Filter 3 Hit
1	0	0	Filter 4 Hit
1	0	1	Filter 5 Hit
1	1	0	Filter 6 Hit
1	1	1	Filter 7 Hit

The IDHITx indicators are always related to the message in the foreground buffer (RxFG). When a message gets shifted into the foreground buffer of the receiver FIFO the indicators are updated as well.

3.3.1.13 Reserved Registers

These registers are reserved for factory testing of the MSCAN module and are not available in normal system operation modes.

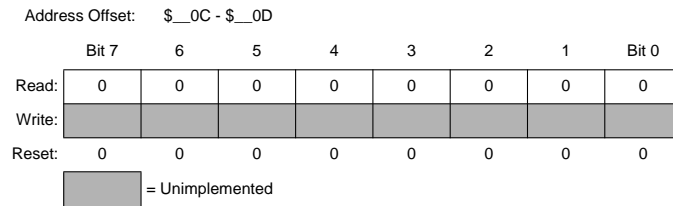

Figure 3-13 Reserved Registers

Read: always read \$00 in normal system operation modes

Write: Unimplemented in normal system operation modes

NOTE: Writing to these registers when in special modes can alter the MSCAN functionality.

3.3.1.14 MSCAN Receive Error Counter Register (CANRXERR)

This register reflects the status of the MSCAN receive error counter.

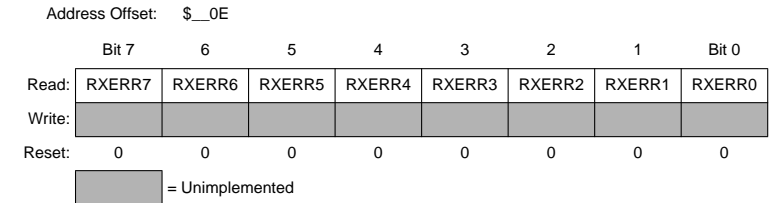

Figure 3-14 MSCAN Receive Error Counter Register (CANRXERR)

Read: only when in Sleep Mode (SLPRQ=1 and SLPK=1) or Initialization Mode (INITRQ=1 and INITAK=1)

Write: Unimplemented

NOTE: Reading this register when in any other mode other than Sleep or Initialization Mode, may return an incorrect value. For MCUs with dual CPUs, this may result in a CPU fault condition.

NOTE: Writing to this register when in special modes can alter the MSCAN functionality.

3.3.1.15 MSCAN Transmit Error Counter Register (CANTXERR)

This register reflects the status of the MSCAN transmit error counter.



Figure 3-15 MSCAN Transmit Error Counter Register (CANTXERR)

Read: only when in Sleep Mode (SLPRQ=1 and SLPK=1) or Initialization Mode (INITRQ=1 and INITAK=1)

Write: Unimplemented

NOTE: Reading this register when in any other mode other than Sleep or Initialization Mode, may return an incorrect value. For MCUs with dual CPUs, this may result in a CPU fault condition.

NOTE: Writing to this register when in special modes can alter the MSCAN functionality.

3.3.1.16 MSCAN Identifier Acceptance Registers (CANIDAR0-7)

On reception, each message is written into the background receive buffer. The CPU is only signalled to read the message if it passes the criteria in the identifier acceptance and identifier mask registers (accepted); otherwise, the message is overwritten by the next message (dropped).

The acceptance registers of the MSCAN are applied on the IDR0 to IDR3 registers **3.3.2.1 Identifier Registers (IDR0-3)** of incoming messages in a bit by bit manner **4.3 Identifier Acceptance Filter**.

For extended identifiers, all four acceptance and mask registers are applied. For standard identifiers, only the first two (CANIDAR0/1, CANIDMR0/1) are applied.

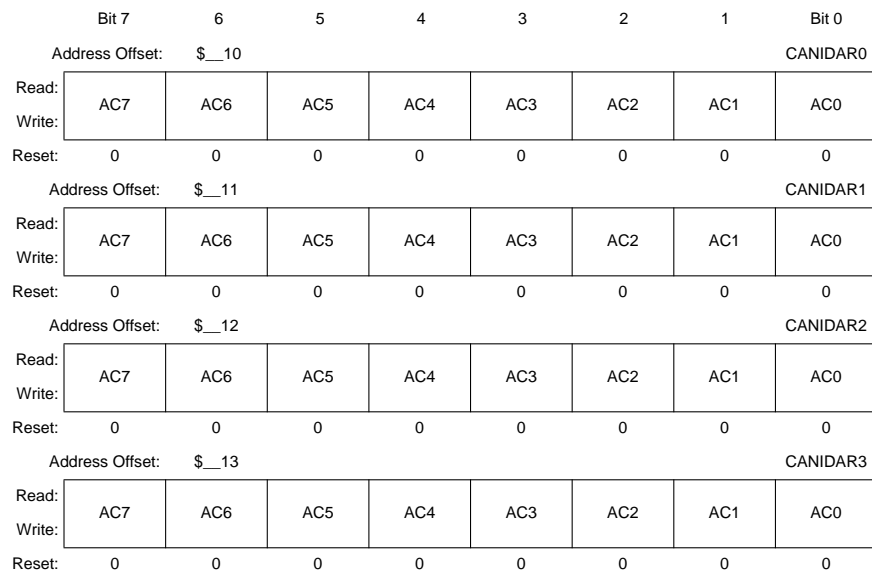

Figure 3-16 MSCAN Identifier Acceptance Registers (1st Bank)

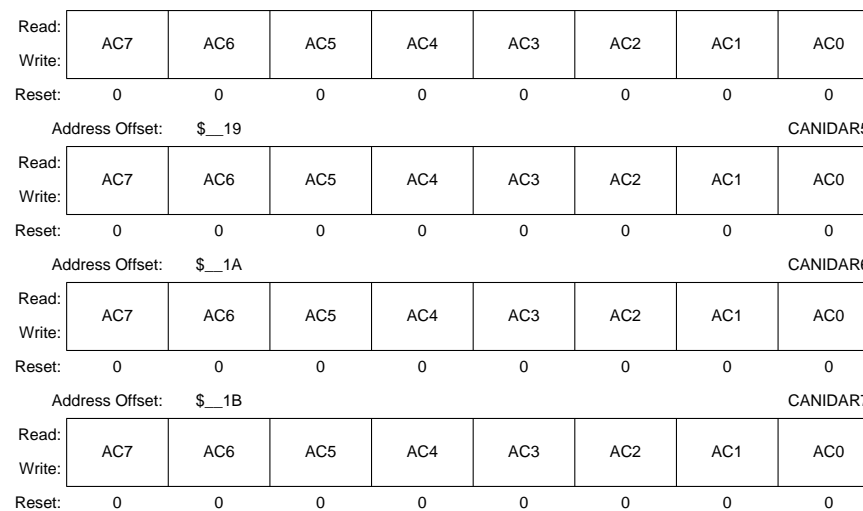

Figure 3-17 MSCAN Identifier Acceptance Registers (2nd Bank)

Read: Anytime

Write: Anytime in Initialization Mode (INITRQ=1 and INITAK=1)

AC7 – AC0 — Acceptance Code Bits

AC7 – AC0 comprise a user defined sequence of bits with which the corresponding bits of the related identifier register (IDRn) of the receive message buffer are compared. The result of this comparison is then masked with the corresponding identifier mask register.

3.3.1.17 MSCAN Identifier Mask Registers (CANIDMR0-7)

The identifier mask register specifies which of the corresponding bits in the identifier acceptance register are relevant for acceptance filtering. To receive standard identifiers in 32 bit filter mode, it is required to program the last three bits (AM2 - AM0) in the mask registers CANIDMR1 and CANIDMR5 to “don’t care”. To receive standard identifiers in 16 bit filter mode, it is required to program the last three bits (AM2 - AM0) in the mask registers CANIDMR1, CANIDMR3, CANIDMR5 and CANIDMR7 to “don’t care”.



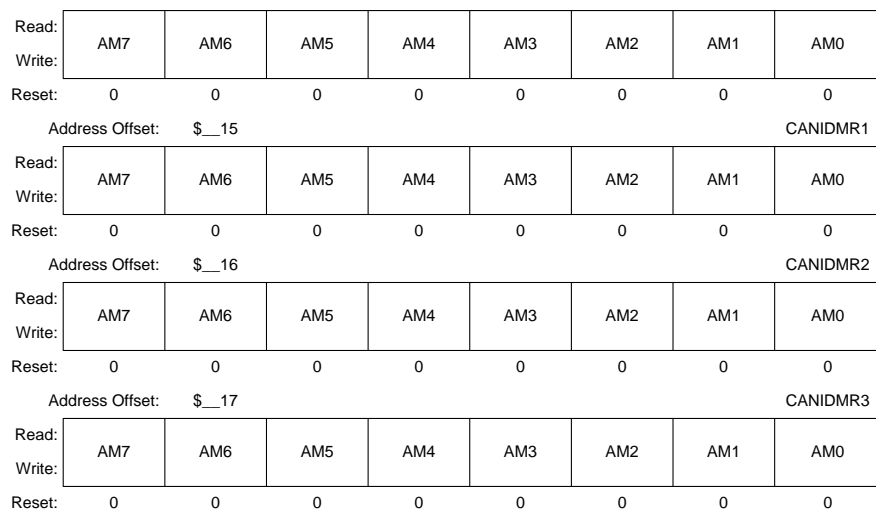

Figure 3-18 MSCAN Identifier Mask Registers (1st Bank)

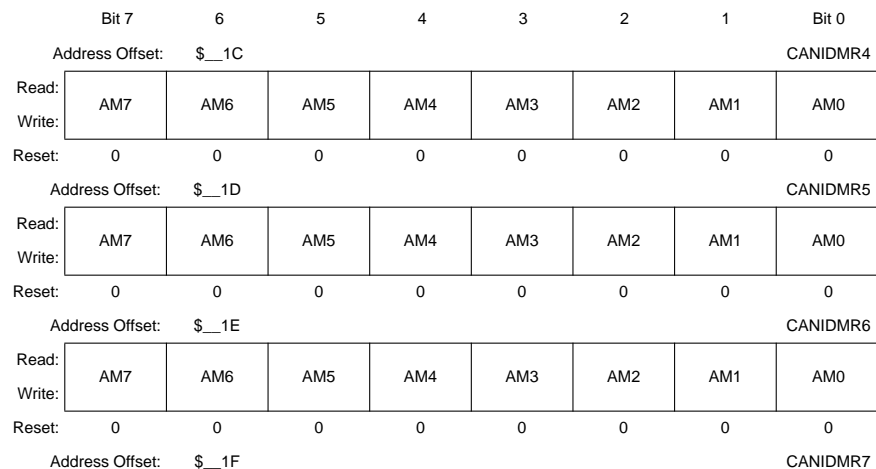

Figure 3-19 MSCAN Identifier Mask Registers (2nd Bank)

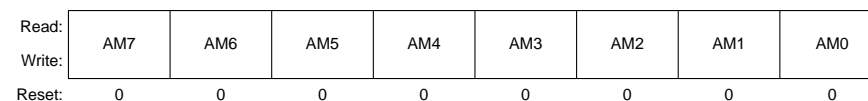

Figure 3-19 MSCAN Identifier Mask Registers (2nd Bank)

Read: Anytime

Write: Anytime in Initialization Mode (INITRQ=1 and INITAK=1)

AM7 – AM0 — Acceptance Mask Bits

If a particular bit in this register is cleared, this indicates that the corresponding bit in the identifier acceptance register must be the same as its identifier bit before a match is detected. The message is accepted if all such bits match. If a bit is set, it indicates that the state of the corresponding bit in the identifier acceptance register does not affect whether or not the message is accepted.

1 = Ignore corresponding acceptance code register bit.

0 = Match corresponding acceptance code register and identifier bits.

3.3.2 Programmer's Model of Message Storage

The following section details the organization of the receive and transmit message buffers and the associated control registers.

For reasons of programmer interface simplification, the receive and transmit message buffers have the same outline. Each message buffer allocates 16 bytes in the memory map containing a 13 byte data structure.

An additional Transmit Buffer Priority Register (TBPR) is defined for the transmit buffers. Within the last two bytes of this memory map the MSCAN stores a special 16-bit time stamp, which is sampled from an internal timer after successful transmission or reception of a message. This feature is only available for transmit and receiver buffers, if the TIME bit is set (**3.3.1.1 MSCAN Control 0 Register (CANCTL0)**).

The Time Stamp register is written by the MSCAN. The CPU can only read these registers.

Addr	Register Name
\$_x0	Identifier Register 0
\$_x1	Identifier Register 1
\$_x2	Identifier Register 2
\$_x3	Identifier Register 3
\$_x4	Data Segment Register 0
\$_x5	Data Segment Register 1
\$_x6	Data Segment Register 2
\$_x7	Data Segment Register 3
\$_x8	Data Segment Register 4
\$_x9	Data Segment Register 5
\$_xA	Data Segment Register 6
\$_xB	Data Segment Register 7
\$_xC	Data Length Register
\$_xD	Transmit Buffer Priority Register ¹
\$_xE	Time Stamp Register (High Byte) ²
\$_xF	Time Stamp Register (Low Byte) ³

Table 3-9 Message Buffer Organization

- NOTES:
 1. Not Applicable for Receive Buffers
 2. Read-Only for CPU
 3. Read-Only for CPU

Figure 3-20 shows the common 13 byte data structure of receive and transmit buffers for extended identifiers. The mapping of standard identifiers into the IDR registers is shown in Figure 3-21.

All bits of the receive and transmit buffers are 'x' out of reset because of RAM based implementation¹. All reserved or unused bits of the receive and transmit buffers are always read 'x'.

Register name	Bit 7	6	5	4	3	2	1	Bit 0	ADDR
IDR0	ID28	ID27	ID26	ID25	ID24	ID23	ID22	ID21	\$_x0
IDR1	ID20	ID19	ID18	SRR (=1)	IDE (=1)	ID17	ID16	ID15	\$_x1
IDR2	ID14	ID13	ID12	ID11	ID10	ID9	ID8	ID7	\$_x2
IDR3	ID6	ID5	ID4	ID3	ID2	ID1	ID0	RTR	\$_x3

= Unused¹

Figure 3-20 Receive / Transmit Message Buffer Extended Identifier

- NOTES:
 1. Exception: The Transmit Priority Registers are "0" out of reset

Register name	Bit 7	6	5	4	3	2	1	Bit 0	ADDR
DSR0	DB7	DB6	DB5	DB4	DB3	DB2	DB1	DB0	\$_x4
DSR1	DB7	DB6	DB5	DB4	DB3	DB2	DB1	DB0	\$_x5
DSR2	DB7	DB6	DB5	DB4	DB3	DB2	DB1	DB0	\$_x6
DSR3	DB7	DB6	DB5	DB4	DB3	DB2	DB1	DB0	\$_x7
DSR4	DB7	DB6	DB5	DB4	DB3	DB2	DB1	DB0	\$_x8
DSR5	DB7	DB6	DB5	DB4	DB3	DB2	DB1	DB0	\$_x9
DSR6	DB7	DB6	DB5	DB4	DB3	DB2	DB1	DB0	\$_xA
DSR7	DB7	DB6	DB5	DB4	DB3	DB2	DB1	DB0	\$_xB
DLR					DLC3	DLC2	DLC1	DLC0	\$_xC

= Unused¹

Figure 3-20 Receive / Transmit Message Buffer Extended Identifier

- NOTES:
 1. Unused bits are always read 'x'

Read: Anytime for transmit buffers; only when RXF flag is set for receive buffers (see 3.3.1.5 MSCAN Receiver Flag Register (CANRFLG)).

Write: Anytime for transmit buffers when TXEx flag is set (see 3.3.1.7 MSCAN Transmitter Flag Register (CANTFLG)) and the corresponding transmit buffer is selected in CANTBSEL (see 3.3.1.11 MSCAN Transmit Buffer Selection (CANTBSEL)); unimplemented for receive buffers

Reset: \$xx because of RAM based implementation

Register name	Bit 7	6	5	4	3	2	1	Bit 0	ADDR
IDR0	ID10	ID9	ID8	ID7	ID6	ID5	ID4	ID3	\$_x0
IDR1	ID2	ID1	ID0	RTR	IDE (=0)				\$_x1
IDR2									\$_x2
IDR3									\$_x3

= Unused¹

Figure 3-21 Standard Identifier Mapping

NOTES:

1. Unused bits are always read 'x'

3.3.2.1 Identifier Registers (IDR0-3)

The identifier registers for an extended format identifier consist of a total of 32 bits; ID28 - ID0, SRR, IDE, and RTR bits. The identifier registers for a standard format identifier consist of a total of 13 bits; ID10 - ID0, RTR, and IDE bits.

ID28 - ID0 — Extended format identifier

The identifiers consist of 29 bits (ID28 - ID0) for the extended format. ID28 is the most significant bit and is transmitted first on the bus during the arbitration procedure. The priority of an identifier is defined to be highest for the smallest binary number.

ID10 - ID0 — Standard format identifier

The identifiers consist of 11 bits (ID10 - ID0) for the standard format. ID10 is the most significant bit and is transmitted first on the bus during the arbitration procedure. The priority of an identifier is defined to be highest for the smallest binary number.

SRR — Substitute Remote Request

This fixed recessive bit is used only in extended format. It must be set to 1 by the user for transmission buffers and is stored as received on the CAN bus for receive buffers.

IDE — ID Extended

This flag indicates whether the extended or standard identifier format is applied in this buffer. In the case of a receive buffer, the flag is set as received and indicates to the CPU how to process the buffer identifier registers. In the case of a transmit buffer, the flag indicates to the MSCAN what type of identifier to send.

- 1 = Extended format (29 bit)
- 0 = Standard format (11 bit)

RTR — Remote Transmission Request

This flag reflects the status of the Remote Transmission Request bit in the CAN frame. In the case of a receive buffer, it indicates the status of the received frame and supports the transmission of an answering frame in software. In the case of a transmit buffer, this flag defines the setting of the RTR bit to be sent.

- 1 = Remote frame
- 0 = Data frame

3.3.2.2 Data Segment Registers (DSR0-7)

The eight data segment registers, each with bits DB7-DB0, contain the data to be transmitted or received. The number of bytes to be transmitted or received is determined by the data length code in the corresponding DLR register.

DB7 - DB0 — Data Bits 7-0

3.3.2.3 Data Length Register (DLR)

This register keeps the data length field of the CAN frame.

DLC3 - DLC0 — Data Length Code bits

The data length code contains the number of bytes (data byte count) of the respective message. During the transmission of a remote frame, the data length code is transmitted as programmed while the number of transmitted data bytes is always 0. The data byte count ranges from 0 to 8 for a data frame.

Table 3-10 shows the effect of setting the DLC bits.

Table 3-10 Data length codes

Data length code				Data byte count
DLC3	DLC2	DLC1	DLC0	
0	0	0	0	0
0	0	0	1	1
0	0	1	0	2
0	0	1	1	3
0	1	0	0	4
0	1	0	1	5
0	1	1	0	6
0	1	1	1	7
1	0	0	0	8

3.3.2.4 Transmit Buffer Priority Register (TBPR)

This register defines the local priority of the associated message buffer. The local priority is used for the internal prioritization process of the MSCAN and is defined to be highest for the smallest binary number. The MSCAN implements the following internal prioritization mechanisms:

- All transmission buffers with a cleared TXEx flag participate in the prioritization immediately before the SOF (Start of Frame) is sent.

- The transmission buffer with the lowest local priority field wins the prioritization.

In cases of more than one buffer having the same lowest priority, the message buffer with the lower index number wins.

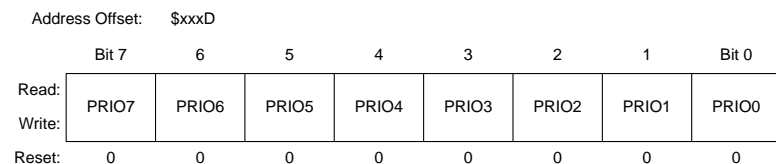

Figure 3-22 Transmit Buffer Priority Register (TBPR)

Read: Anytime

Write: Anytime

3.3.2.5 Time Stamp Register (TSRH, TSRL)

If the TIME bit is enabled, the MSCAN will write a special time stamp to the respective registers in the active transmit or receive buffer as soon as a message has been acknowledged on the CAN bus (**3.3.1.1 MSCAN Control 0 Register (CANCTL0)**). The time stamp is written on the bit sample point for the recessive bit of the ACK delimiter in the CAN frame. In case of a transmission, the CPU can only read the time stamp after the respective transmit buffer has been flagged empty.

The timer value, which is used for stamping, is taken from a free running internal CAN bit clock. A timer overrun is not indicated by the MSCAN. The timer is reset (all bits set to “0”) during Initialization Mode. The CPU can only read the Time Stamp registers.



Figure 3-23 Time Stamp Register (TSRH - High Byte)

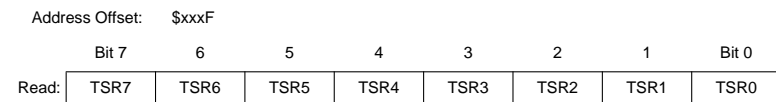

Figure 3-24 Time Stamp Register (TSRL - Low Byte)

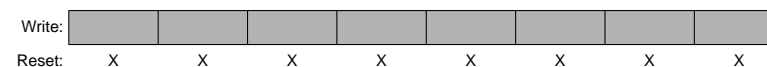

Figure 3-24 Time Stamp Register (TSRL - Low Byte)

Read: Anytime

Write: Unimplemented

Section 4 Functional Description

4.1 General

This section provides a complete functional description of the MSCAN. It describes each of the features and modes listed in the introduction.

4.2 Message Storage

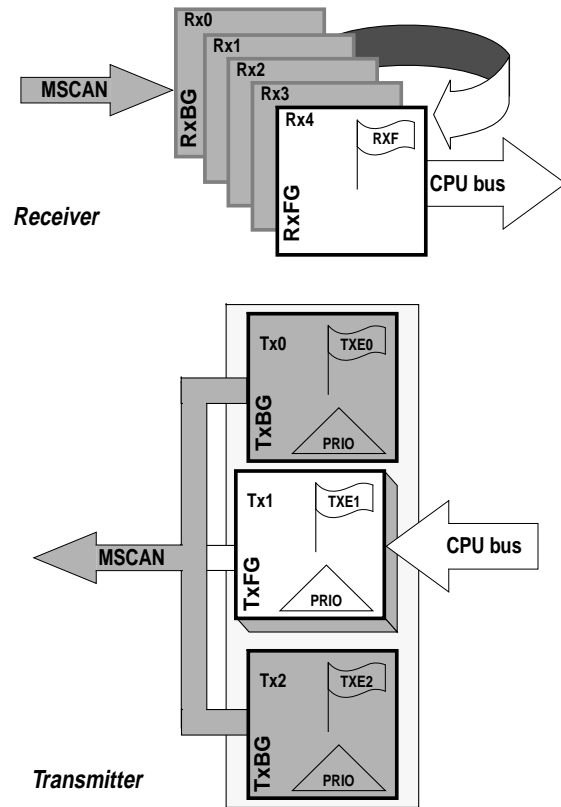

Figure 4-1 User Model for Message Buffer Organization

MSCAN facilitates a sophisticated message storage system which addresses the requirements of a broad range of network applications.

4.2.1 Message Transmit Background

Modern application layer software is built upon two fundamental assumptions:

- Any CAN node is able to send out a stream of scheduled messages without releasing the bus between the two messages. Such nodes arbitrate for the bus immediately after sending the previous message and only release the bus in case of lost arbitration.
- The internal message queue within any CAN node is organized such that the highest priority message is sent out first, if more than one message is ready to be sent.

The above behavior cannot be achieved with a single transmit buffer. That buffer must be reloaded right after the previous message is sent. This loading process lasts a finite amount of time and has to be completed within the Inter-Frame Sequence (IFS)¹ to be able to send an uninterrupted stream of messages. Even if this is feasible for limited CAN bus speeds, it requires that the CPU react with short latencies to the transmit interrupt.

A double buffer scheme de-couples the reloading of the transmit buffer from the actual message sending and, as such, reduces the reactivity requirements on the CPU. Problems can arise if the sending of a message is finished while the CPU re-loads the second buffer. No buffer would then be ready for transmission and the bus would be released.

At least three transmit buffers are required to meet the first of the above requirements under all circumstances. The MSCAN has three transmit buffers.

The second requirement calls for some sort of internal prioritization which the MSCAN implements with the “local priority” concept described in **4.2.2 Transmit Structures**.

4.2.2 Transmit Structures

The MSCAN has a triple transmit buffer scheme which allows multiple messages to be set up in advance and achieve an optimized real-time performance. The three buffers are arranged as shown in **Figure 4-1 User Model for Message Buffer Organization**.

All three buffers have a 13 byte data structure similar to the outline of the receive buffers **3.3.2 Programmer’s Model of Message Storage**. An additional **3.3.2.4 Transmit Buffer Priority Register (TBPR)** contains an 8-bit “Local Priority” field (PRIO) (see **3.3.2.4 Transmit Buffer Priority Register (TBPR)**). The remaining two bytes are used for time stamping of a message, if required (see **3.3.2.5 Time Stamp Register (TSRH, TSRL)**).

To transmit a message, the CPU has to identify an available transmit buffer which is indicated by a set Transmitter Buffer Empty (TXEx) flag **3.3.1.7 MSCAN Transmitter Flag Register (CANTFLG)**. If a transmit buffer is available, the CPU has to set a pointer to this buffer by writing to the CANTBSEL register (**3.3.1.11 MSCAN Transmit Buffer Selection (CANTBSEL)**). This makes the respective buffer accessible within the CANTXFG address space **3.3.2 Programmer’s Model of Message Storage**. The algorithmic feature associated with the CANTBSEL register simplifies the transmit buffer selection. In addition this scheme makes the handler software simpler as only one address area is applicable for the transmit process. In addition the required address space is minimized.

The CPU then stores the identifier, the control bits and the data content into one of the transmit buffers. Finally, the buffer is flagged as ready for transmission by clearing the associated TXE flag.

NOTES:

1. Reference the Bosch CAN 2.0A/B protocol specification dated September 1991.

The MSCAN then schedules the message for transmission and signals the successful transmission of the buffer by setting the associated TXE flag. A transmit interrupt **4.9.1 Transmit Interrupt** is generated¹ when TXEx is set and can be used to drive the application software to re-load the buffer.

In case more than one buffer is scheduled for transmission when the CAN bus becomes available for arbitration, the MSCAN uses the “local priority” setting of the three buffers to determine the prioritization. For this purpose, every transmit buffer has an 8-bit local priority field (PRIO). The application software programs this field when the message is set up. The local priority reflects the priority of this particular message relative to the set of messages being transmitted from this node. The lowest binary value of the PRIO field is defined to be the highest priority. The internal scheduling process takes place whenever the MSCAN arbitrates for the bus. This is also the case after the occurrence of a transmission error.

When a high priority message is scheduled by the application software, it may become necessary to abort a lower priority message in one of the three transmit buffers. As messages that are already in transmission cannot be aborted, the user has to request the abort by setting the corresponding Abort Request bit (ABTRQ) **3.3.1.9 MSCAN Transmitter Message Abort Control (CANTARQ)**. The MSCAN then grants the request, if possible, by: 1) setting the corresponding Abort Acknowledge flag (ABTAK) in the CANTAACK register, 2) setting the associated TXE flag to release the buffer, and 3) generating a transmit interrupt. The transmit interrupt handler software can tell from the setting of the ABTAK flag whether the message was aborted (ABTAK=1) or sent (ABTAK=0).

4.2.3 Receive Structures

The received messages are stored in a five stage input FIFO. The five message buffers are alternately mapped into a single memory area **Figure 4-1 User Model for Message Buffer Organization**. While the background receive buffer (RxBG) is exclusively associated with the MSCAN, the foreground receive buffer (RxFG) is addressable by the CPU **Figure 4-1 User Model for Message Buffer Organization**. This scheme simplifies the handler software as only one address area is applicable for the receive process.

All receive buffers have a size of 15 bytes to store the CAN control bits, the identifier (standard or extended), the data contents and a time stamp, if enabled (for details **3.3.2 Programmer’s Model of Message Storage**)².

The Receiver Full flag (RXF) **3.3.1.5 MSCAN Receiver Flag Register (CANRFLG)** signals the status of the foreground receive buffer. When the buffer contains a correctly received message with a matching identifier, this flag is set.

On reception, each message is checked to see if it passes the filter (**4.3 Identifier Acceptance Filter**) and in parallel, is written into the active RxBG. After successful reception of a valid message the MSCAN shifts the content of RxBG into the receiver FIFO³, sets the RXF flag, and generates a receive interrupt **4.9.2 Receive Interrupt** to the CPU⁴. The user’s receive handler has to read the received message from the RxFG and then reset the RXF flag to acknowledge the interrupt and to release the foreground buffer. A new message, which can follow immediately after the IFS field of the CAN frame, is received into the

NOTES:

1. The transmit interrupt occurs only if not masked. A polling scheme can be applied on TXEx also.
2. Reference the Bosch CAN 2.0A/B protocol specification dated September 1991 for details.
3. Only if the RXF flag is not set.
4. The receive interrupt occurs only if not masked. A polling scheme can be applied on RXF also.

next available RxBG. If the MSCAN receives an invalid message in its RxBG (wrong identifier, transmission errors etc.) the actual contents of the buffer will be over-written by the next message. The buffer will then not be shifted into the FIFO.

When the MSCAN module is transmitting, the MSCAN receives its own transmitted messages into the background receive buffer, RxBG, but does not shift it into the receiver FIFO, generate a receive interrupt, or acknowledge its own messages on the CAN bus. The exception to this rule is in loop back mode **3.3.1.2 MSCAN Control 1 Register (CANCTL1)** where the MSCAN treats its own messages exactly like all other incoming messages. The MSCAN receives its own transmitted messages in the event that it loses arbitration¹. If arbitration is lost, the MSCAN must be prepared to become a receiver.

An overrun condition occurs when all receive message buffers in the FIFO are filled with correctly received messages with accepted identifiers and another message is correctly received from the bus with an accepted identifier. The latter message is discarded and an error interrupt with overrun indication is generated if enabled **4.9.4 Error Interrupt**. The MSCAN is still able to transmit messages while the receiver FIFO being filled, but all incoming messages are discarded. As soon as a receive buffer in the FIFO is available again, new valid messages will be accepted.

4.3 Identifier Acceptance Filter

The MSCAN Identifier Acceptance Registers (**3.3.1.12 MSCAN Identifier Acceptance Control Register (CANIDAC)**) define the acceptable patterns of the standard or extended identifier (ID10 - ID0 or ID28 - ID0). Any of these bits can be marked ‘don’t care’ in the MSCAN Identifier Mask Registers **3.3.1.17 MSCAN Identifier Mask Registers (CANIDMR0-7)**.

A filter hit is indicated to the application software by a set Receive Buffer Full flag (RXF=1) and three bits in the CANIDAC register **3.3.1.12 MSCAN Identifier Acceptance Control Register (CANIDAC)**. These Identifier Hit flags (IDHIT2-0) clearly identify the filter section that caused the acceptance. They simplify the application software’s task to identify the cause of the receiver interrupt. In case more than one hit occurs (two or more filters match), the lower hit has priority.

A very flexible programmable generic identifier acceptance filter has been introduced to reduce the CPU interrupt loading. The filter is programmable to operate in four different modes²:

- Two identifier acceptance filters, each to be applied to a) the full 29 bits of the extended identifier and to the following bits of the CAN 2.0B frame: Remote Transmission Request (RTR), Identifier Extension (IDE), and Substitute Remote Request (SRR) or b)³ the 11 bits of the standard identifier plus the RTR and IDE bits of the CAN 2.0A/B messages. This mode implements two filters for a full length CAN 2.0B compliant extended identifier. **Figure 4-2** shows how the first 32-bit filter bank (CANIDAR0-3, CANIDMR0-3) produces a filter 0 hit. Similarly, the second filter bank (CANIDAR4-7, CANIDMR4-7) produces a filter 1 hit.

NOTES:

1. Reference the Bosch CAN 2.0A/B protocol specification dated September 1991 for details.
2. For a better understanding of references made within the filter mode description, reference the Bosch specification dated September 1991 which details the CAN 2.0A/B protocol.
3. Although this mode can be used for standard identifiers, it is recommended to use the four or eight identifier acceptance filters for standard identifiers

- Four identifier acceptance filters, each to be applied to a) the 14 most significant bits of the extended identifier plus the SRR and IDE bits of CAN 2.0B messages or b) the 11 bits of the standard identifier, the RTR and IDE bits of CAN 2.0A/B messages. **Figure 4-3** shows how the first 32-bit filter bank (CANIDAR0-3, CANIDMR0-3) produces filter 0 and 1 hits. Similarly, the second filter bank (CANIDAR4-7, CANIDMR4-7) produces filter 2 and 3 hits.
- Eight identifier acceptance filters, each to be applied to the first 8 bits of the identifier. This mode implements eight independent filters for the first 8 bits of a CAN 2.0A/B compliant standard identifier or a CAN 2.0B compliant extended identifier. **Figure 4-4** shows how the first 32-bit filter bank (CANIDAR0-3, CANIDMR0-3) produces filter 0 to 3 hits. Similarly, the second filter bank (CANIDAR4-7, CANIDMR4-7) produces filter 4 to 7 hits.
- Closed filter. No CAN message is copied into the foreground buffer RxFG, and the RXF flag is never set.

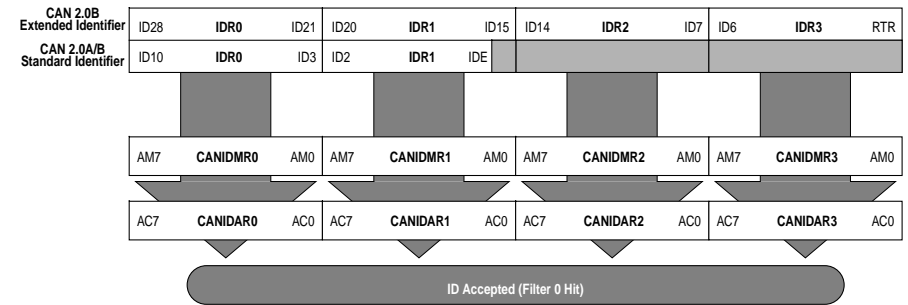

Figure 4-2 32-bit Maskable Identifier Acceptance Filter

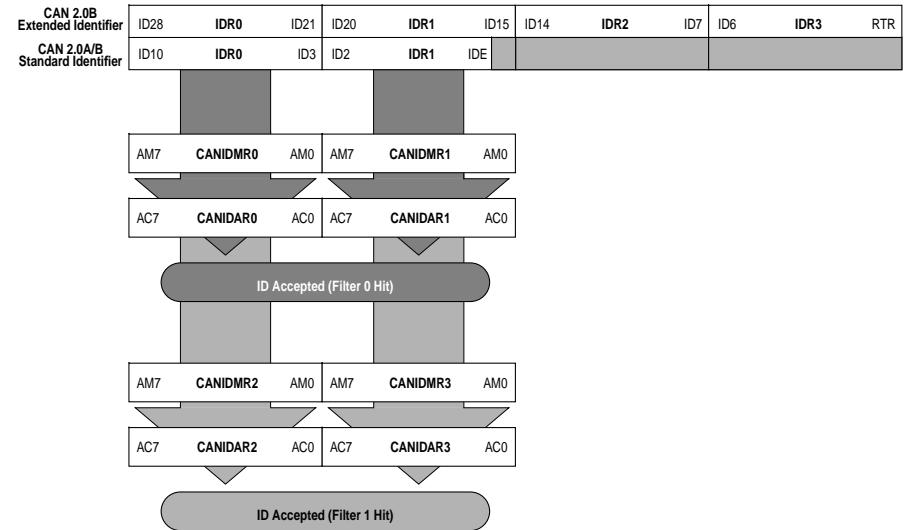

Figure 4-3 16-bit Maskable Identifier Acceptance Filters

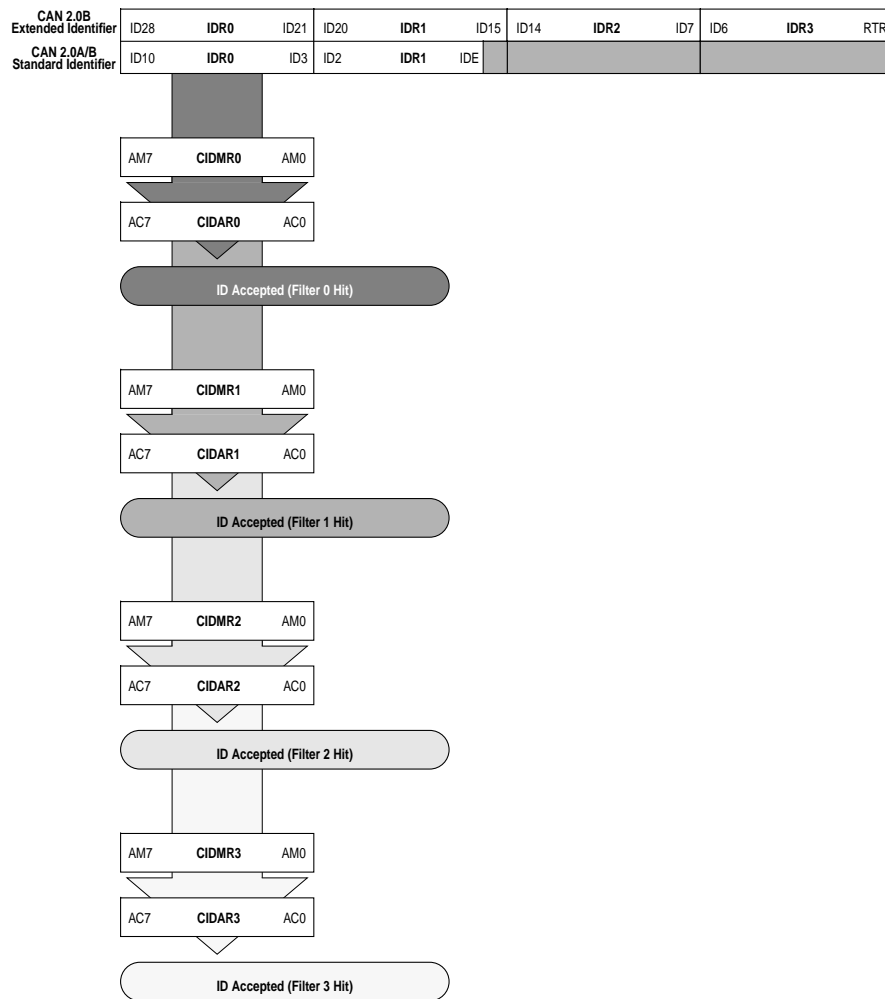

Figure 4-4 8-bit Maskable Identifier Acceptance Filters

4.3.1 Protocol Violation Protection

The MSCAN protects the user from accidentally violating the CAN protocol through programming errors. The protection logic implements the following features:

- The receive and transmit error counters cannot be written or otherwise manipulated.
- All registers which control the configuration of the MSCAN cannot be modified while the MSCAN is on-line. The MSCAN has to be in Initialization Mode. The corresponding INITRQ/INITAK handshake bits in the CANCTL0/CANCTL1 registers **3.3.1.1 MSCAN Control 0 Register (CANCTL0)** serve as a lock to protect the following registers:
 - MSCAN Control 1 Register (CANCTL1)
 - MSCAN Bus Timing Registers 0 and 1 (CANBTR0, CANBTR1)
 - MSCAN Identifier Acceptance Control Register (CANIDAC)
 - MSCAN Identifier Acceptance Registers (CANIDAR0-7)
 - MSCAN Identifier Mask Registers (CANIDMR0-7)
- The TXCAN pin is immediately forced to a recessive state when the MSCAN goes into the Power Down Mode or Initialization Mode (see **4.6.6 MSCAN Power Down Mode** and **4.6.5 MSCAN Initialization Mode**).
- The MSCAN enable bit (CANE) is only writable once in normal system operation modes as further protection against inadvertently disabling the MSCAN.

4.3.2 Clock System

Figure 4-5 shows the structure of the MSCAN clock generation circuitry. With this flexible clocking scheme, the MSCAN is able to handle CAN bus rates ranging from 10 Kbps up to 1 Mbps.

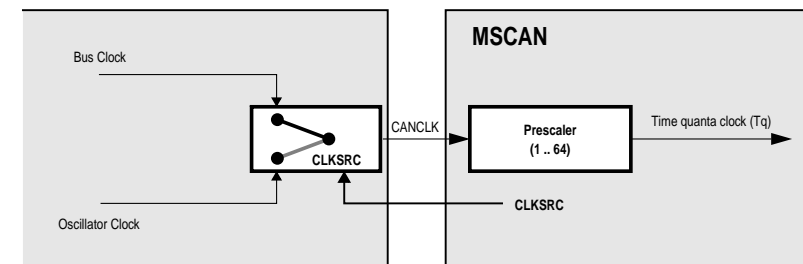

Figure 4-5 MSCAN Clocking Scheme

The clock source bit (CLKSRC) in the CANCTL1 register **3.3.1.2 MSCAN Control 1 Register (CANCTL1)** defines whether the internal CANCLK is connected to the output of a crystal oscillator (Oscillator Clock) or to the Bus Clock.

The clock source has to be chosen such that the tight oscillator tolerance requirements (up to 0.4%) of the CAN protocol are met. Additionally, for high CAN bus rates (1 Mbps), a 45%-55% duty cycle of the clock is required.

If the Bus Clock is generated from a PLL, it is recommended to select the Oscillator Clock rather than the Bus Clock due to jitter considerations, especially at the faster CAN bus rates.

For microcontrollers without a clock and reset generator (CRG), CANCLK is driven from the crystal oscillator (Oscillator Clock).

A programmable prescaler generates the time quanta (Tq) clock from CANCLK. A time quantum is the atomic unit of time handled by the MSCAN.

$$f_{Tq} = \frac{f_{CANCLK}}{\text{(Prescaler value)}}$$

A bit time is subdivided into three segments^{1 2} (reference **Figure 4-6**):

- SYNC_SEG: This segment has a fixed length of one time quantum. Signal edges are expected to happen within this section.
- Time Segment 1: This segment includes the PROP_SEG and the PHASE_SEG1 of the CAN standard. It can be programmed by setting the parameter TSEG1 to consist of 4 to 16 time quanta.
- Time Segment 2: This segment represents the PHASE_SEG2 of the CAN standard. It can be programmed by setting the TSEG2 parameter to be 2 to 8 time quanta long.

$$\text{Bit Rate} = \frac{f_{Tq}}{\text{(number of Time Quanta)}}$$

NOTES:

1. For further explanation of the under-lying concepts please refer to ISO/DIS 11519-1, Section 10.3.
2. Reference the Bosch CAN 2.0A/B protocol specification dated September 1991 for bit timing.

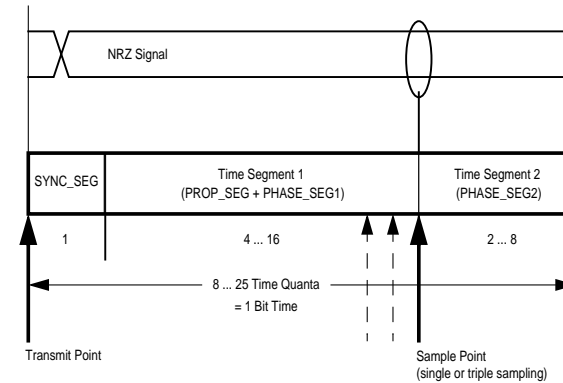

Figure 4-6 Segments within the Bit Time

Table 4-1 Time Segment Syntax

Syntax	Description
SYNC_SEG	System expects transitions to occur on the bus during this period.
Transmit Point	A node in transmit mode transfers a new value to the CAN bus at this point.
Sample Point	A node in receive mode samples the bus at this point. If the three samples per bit option is selected, then this point marks the position of the third sample.

The Synchronization Jump Width¹ can be programmed in a range of 1 to 4 time quanta by setting the SJW parameter.

The above parameters are set by programming the MSCAN Bus Timing Registers (CANBTR0, CANBTR1) (see **3.3.1.3 MSCAN Bus Timing Register 0 (CANBTR0)** and **3.3.1.4 MSCAN Bus Timing Register 1 (CANBTR1)**).

Table 4-2 gives an overview of the CAN compliant segment settings and the related parameter values.

NOTE: It is the user's responsibility to ensure the bit time settings are in compliance with the CAN standard.

NOTES:

1. Reference the Bosch CAN 2.0A/B protocol specification dated September 1991 for bit timing.

Time Segment 1	TSEG1	Time Segment 2	TSEG2	Synchronization Jump Width	SJW
5 .. 10	4 .. 9	2	1	1 .. 2	0 .. 1
4 .. 11	3 .. 10	3	2	1 .. 3	0 .. 2
5 .. 12	4 .. 11	4	3	1 .. 4	0 .. 3
6 .. 13	5 .. 12	5	4	1 .. 4	0 .. 3
7 .. 14	6 .. 13	6	5	1 .. 4	0 .. 3
8 .. 15	7 .. 14	7	6	1 .. 4	0 .. 3
9 .. 16	8 .. 15	8	7	1 .. 4	0 .. 3

Table 4-2 CAN Standard Compliant Bit Time Segment Settings

4.4 Timer Link

The MSCAN generates an internal time stamp whenever a valid frame is received or transmitted and the TIME bit is enabled. Because the CAN specification defines a frame to be valid if no errors occur before the End of Frame (EOF) field is transmitted successfully, the actual value of an internal timer is written at EOF to the appropriate time stamp position within the transmit buffer. For receive frames the time stamp is written to the receive buffer.

4.5 Modes of Operation

4.5.1 Normal Modes

The MSCAN module behaves as described within this specification in all normal system operation modes.

4.5.2 Special Modes

The MSCAN module behaves as described within this specification in all special system operation modes.

4.5.3 Emulation Modes

In all emulation modes, the MSCAN module behaves just like normal system operation modes as described within this specification.

4.5.4 Listen-Only Mode

In an optional bus monitoring mode (Listen-Only), the CAN node is able to receive valid data frames and valid remote frames, but it sends only “recessive” bits on the CAN bus. In addition it cannot start a transmission. If the MAC sub-layer is required to send a “dominant” bit (ACK bit, overload flag, active

error flag), the bit is rerouted internally so that the MAC sub-layer monitors this “dominant” bit, although the CAN bus may remain in recessive state externally.

4.5.5 Security Modes

The MSCAN module has no security features.

4.6 Low Power Options

If the MSCAN is disabled (CANE=0), the MSCAN clocks are stopped for power savings.

If the MSCAN is enabled (CANE=1), the MSCAN has two additional modes with reduced power consumption, compared to Normal Mode: Sleep and Power Down Mode. In Sleep Mode power consumption is reduced by stopping all clocks except those to access the registers from the CPU side. In Power Down Mode, all clocks are stopped and no power is consumed.

Table 4-3 summarizes the combinations of MSCAN and CPU modes. A particular combination of modes is entered by the given settings on the CSWAI and SLPRQ/SLPAK bits.

For all modes, an MSCAN Wake-Up interrupt can only occur if the MSCAN is in Sleep Mode (SLPRQ=1 and SLPK=1), wake-up functionality is enabled (WUPE=1) and the Wake-Up interrupt is enabled (WUPIE=1).

Table 4-3 CPU vs. MSCAN Operating Modes

CPU Mode	MSCAN Mode			
	Normal	Reduced Power Consumption		
		Sleep	Power Down	Disabled (CANE=0)
RUN	CSWAI = X ¹ SLPRQ = 0 SLPAK = 0	CSWAI = X SLPRQ = 1 SLPAK = 1		CSWAI = X SLPRQ = X SLPAK = X
WAIT	CSWAI = 0 SLPRQ = 0 SLPAK = 0	CSWAI = 0 SLPRQ = 1 SLPAK = 1	CSWAI = 1 SLPRQ = X SLPAK = X	CSWAI = X SLPRQ = X SLPAK = X
STOP			CSWAI = X SLPRQ = X SLPAK = X	CSWAI = X SLPRQ = X SLPAK = X

NOTES:
1. 'X' means don't care.

4.6.1 CPU Run Mode

As can be seen in **Table 4-3 CPU vs. MSCAN Operating Modes**, only MSCAN Sleep Mode is available as low power option, when CPU is in Run Mode.

4.6.2 CPU Wait Mode

The WAI instruction puts the MCU in a low power consumption stand-by mode. If the CSWAI bit is set, then additional power can be saved in Power Down Mode since the CPU clocks are stopped. After leaving this Power Down Mode the MSCAN restarts its internal controllers and enters Normal Mode again.

While the CPU is in Wait Mode, the MSCAN can be operated in Normal Mode and generate interrupts (registers can be accessed via background debug mode). The MSCAN can also operate in any of the low power modes depending on the values of the SLPRQ/SLPAK and CSWAI bits as seen in **Table 4-3 CPU vs. MSCAN Operating Modes**.

4.6.3 CPU Stop Mode

The STOP instruction puts the MCU in a low power consumption stand-by mode. In Stop Mode, the MSCAN set in Power Down mode regardless of the value of the SLPRQ/SLPAK and CSWAI bits **Table 4-3**.

4.6.4 MSCAN Sleep Mode

The CPU can request the MSCAN to enter this low power mode by asserting the SLPRQ bit in the CANCTL0 register. The time when the MSCAN enters Sleep Mode depends on a fixed synchronization delay and its current activity:

- If there are one or more message buffers scheduled for transmission (TXEx = 0), the MSCAN will continue to transmit until all transmit message buffers are empty (TXEx = 1, transmitted successfully or aborted) and then goes into Sleep Mode.
- If it is receiving, it continues to receive and goes into Sleep Mode as soon as the CAN bus next becomes idle.
- If it is neither transmitting nor receiving, it immediately goes into Sleep Mode.

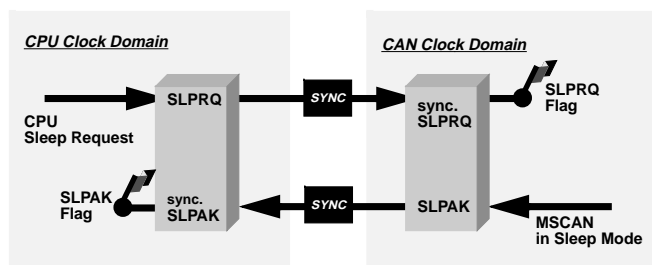

Figure 4-7 Sleep Request / Acknowledge Cycle

NOTE: The application software must avoid setting up a transmission (by clearing one or more TXEx flag(s)) and immediately request Sleep Mode (by setting SLPRQ). It depends on the exact sequence of operations whether the MSCAN starts transmitting or goes into Sleep Mode directly.

If Sleep Mode is active, the SLPRQ and SLPK bits are set (**Figure 4-7**). The application software must use SLPK as a handshake indication for the request (SLPRQ) to go into Sleep Mode.

When in Sleep Mode (SLPRQ=1 and SLPK=1), the MSCAN stops its internal clocks. However, clocks to allow register accesses from the CPU side still run.

If the MSCAN is in Bus-Off state, it stops counting the 128*11 consecutive recessive bits due to the stopped clocks. The TXCAN pin remains in a recessive state. If RXF=1, the message can be read and RXF can be cleared. Shifting a new message into the foreground buffer of the receiver FIFO (RxFG) does not take place while in Sleep Mode.

It is possible to access the transmit buffers and to clear the associated TXE flags. No message abort takes place while in Sleep Mode.

If the WUPE bit in CANCLT0 is not asserted, the MSCAN will mask any activity it detects on CAN. The RXCAN pin is therefore held internally in a recessive state. This locks the MSCAN in Sleep Mode (**Figure 4-8 Simplified State Transitions for Entering/Leaving Sleep Mode**).

The MSCAN is only able to leave Sleep Mode (wake up) when

- bus activity occurs and WUPE=1 or
- the CPU clears the SLPRQ bit

NOTE: The CPU cannot clear the SLPRQ bit before Sleep Mode (SLPRQ=1 and SLPK=1) is active.

After wake-up, the MSCAN waits for 11 consecutive recessive bits to synchronize to the bus. As a consequence, if the MSCAN is woken-up by a CAN frame, this frame is not received.

The receive message buffers (RxFG and RxBG) contain messages if they were received before Sleep Mode was entered. All pending actions will be executed upon wake-up; copying of RxBG into RxFG, message aborts and message transmissions. If the MSCAN is still in Bus-Off state after Sleep Mode was left, it continues counting the 128*11 consecutive recessive bits.

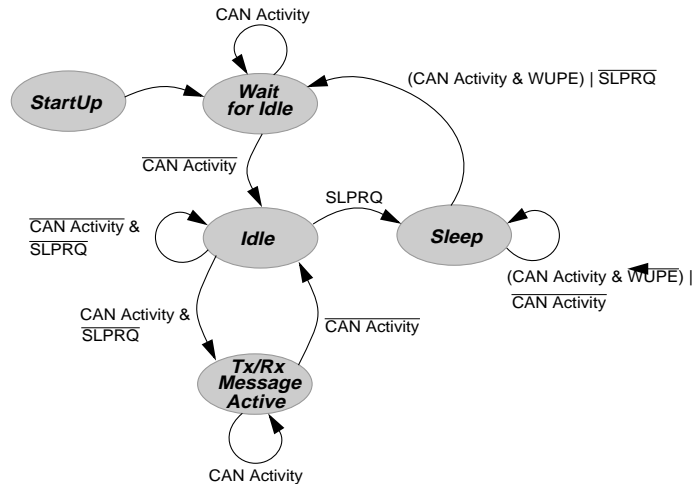

Figure 4-8 Simplified State Transitions for Entering/Leaving Sleep Mode

4.6.5 MSCAN Initialization Mode

In Initialization Mode, any ongoing transmission or reception is immediately aborted and synchronization to the bus is lost potentially causing CAN protocol violations. To protect the CAN bus system from fatal consequences of violations, the MSCAN immediately drives the TXCAN pin into a recessive state.

NOTE: The user is responsible for ensuring that the MSCAN is not active when Initialization Mode is entered. The recommended procedure is to bring the MSCAN into Sleep Mode (SLPRQ=1 and SLPK=1) before setting the INITRQ bit in the CANCTL0 register. Otherwise the abort of an ongoing message can cause an error condition and can have an impact on the other bus devices.

In Initialization Mode, the MSCAN is stopped. However, interface registers can still be accessed. This mode is used to reset the CANCTL0, CANRFLG, CANRIER, CANTFLG, CANTIER, CANTARQ, CANTAACK, CANTBSEL registers to their default values. In addition it enables the configuration of the CANBTR0, CANBTR1 bit timing registers, CANIDAC and the CANIDAR, CANIDMR message filters.

3.3.1.1 MSCAN Control 0 Register (CANCTL0) for a detailed description of the Initialization Mode.

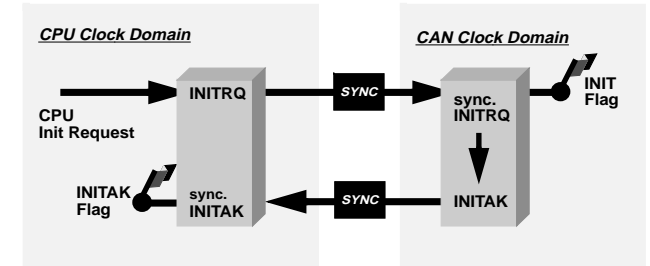

Figure 4-9 Initialization Request/Acknowledge Cycle

Due to independent clock domains within the MSCAN the INITRQ has to be synchronized to all domains by using a special handshake mechanism. This handshake causes additional synchronization delay (Figure 4-9 Initialization Request/Acknowledge Cycle).

If there is no message transfer ongoing on the CAN bus, the minimum delay will be two additional bus clocks and three additional CAN clocks. When all parts of the MSCAN are in Initialization Mode the INITAK flag is set. The application software must use INITAK as a handshake indication for the request (INITRQ) to go into Initialization Mode.

NOTE: The CPU cannot clear the INITRQ bit before Initialization Mode (INITRQ=1 and INITAK=1) is active.

4.6.6 MSCAN Power Down Mode

The MSCAN is in Power Down Mode (Table 4-3) when

- the CPU is in Stop Mode or
- the CPU is in Wait Mode and the CSWAI bit is set.

When entering the Power Down Mode, the MSCAN immediately stops all ongoing transmissions and receptions, potentially causing CAN protocol violations. To protect the CAN bus system from fatal consequences of violations to the above rule, the MSCAN immediately drives the TXCAN pin into a recessive state.

NOTE: The user is responsible for ensuring that the MSCAN is not active when Power Down Mode is entered. The recommended procedure is to bring the MSCAN into Sleep Mode before the STOP or WAI instruction (if CSWAI is set) is executed. Otherwise the abort of an ongoing message can cause an error condition and can have an impact on the other bus devices.

In Power Down Mode, all clocks are stopped and no registers can be accessed. If the MSCAN was not in Sleep Mode before Power Down Mode became active, the module would perform an internal recovery cycle after powering up. This causes some fixed delay before the module enters Normal Mode again.

4.6.7 Programmable Wake-Up Function

The MSCAN can be programmed to wake up the MSCAN as soon as bus activity is detected (see control bit WUPE in **3.3.1.1 MSCAN Control 0 Register (CANCTL0)**). The sensitivity to existing bus action can be modified by applying a low-pass filter function to the RXCAN input line while in Sleep Mode (see control bit WUPM in **3.3.1.2 MSCAN Control 1 Register (CANCTL1)**).

This feature can be used to protect the MSCAN from wake-up due to short glitches on the CAN bus lines. Such glitches can result e.g. from electromagnetic interference within noisy environments.

4.7 Reset Initialization

The reset state of each individual bit is listed within the Register Description section **3.3 Register Descriptions** which details all the registers and their bit-fields.

4.8 General

This section describes all interrupts originated by the MSCAN. It documents the enable bits and generated flags, if applicable. Each interrupt is listed and described separately. The description explains what causes the interrupt, the registers affected, and how the interrupt request is provided to the core.

Table 4-4 CRG Interrupt Vectors

Vector Address	Interrupt Source	CCR Mask	Local Enable	HPRIO Value to Elevate
1	Wake-Up Interrupt (WUPIF)	1 bit	CANRIER (WUPIE)	2
3	Error Interrupts Interrupt (CSCIF, OVRIF)	1 bit	CANRIER (CSCIE, OVRIE)	4
5	Receive Interrupt (RXF)	1 bit	CANRIER (RXFIE)	6
7	Transmit Interrupts (TXE2 - TXE0)	1 bit	CANTIER (TXEIE2 - TXEIE0)	8

NOTES:

1. Wake-Up interrupt vector address is specific to MCU, refer to MCU specification.
2. Wake-Up interrupt HPRIO value is specific to MCU, refer to MCU specification.
3. Error interrupt vector address is specific to MCU, refer to MCU specification.
4. Error interrupt HPRIO value is specific to MCU, refer to MCU specification.
5. Receive interrupt vector address is specific to MCU, refer to MCU specification.
6. Receive interrupt HPRIO value is specific to MCU, refer to MCU specification.
7. Transmit interrupt vector address is specific to MCU, refer to MCU specification.
8. Transmit interrupt HPRIO value is specific to MCU, refer to MCU specification.

4.9 Description of Interrupt Operation

The MSCAN supports four interrupt vectors, any of which can be individually masked (for details see sections **3.3.1.6 MSCAN Receiver Interrupt Enable Register (CANRIER)** to **3.3.1.8 MSCAN Transmitter Interrupt Enable Register (CANTIER)**):

4.9.1 Transmit Interrupt

At least one of the three transmit buffers is empty (not scheduled) and can be loaded to schedule a message for transmission. The TXEx flag of the empty message buffer is set.

4.9.2 Receive Interrupt

A message is successfully received and shifted into the foreground buffer (RxFG) of the receiver FIFO. This interrupt is generated immediately after receiving the EOF symbol. The RXF flag is set. If there are multiple messages in the receiver FIFO, the RXF flag is set as soon as the next message is shifted to the foreground buffer.

4.9.3 Wake-Up Interrupt

Activity on the CAN bus occurred during MSCAN internal Sleep Mode and WUPE **3.3.1.1 MSCAN Control 0 Register (CANCTL0)** enabled.

4.9.4 Error Interrupt

An overrun of the receiver FIFO, error, warning or Bus-Off condition occurred. The **3.3.1.5 MSCAN Receiver Flag Register (CANRFLG)** indicates one of the following conditions:

- Overrun
An overrun condition of the receiver FIFO as described in **4.2.3 Receive Structures** occurred.
- CAN Status Change

The actual value of the Transmit and Receive Error Counters control the bus state of the MSCAN. As soon as the error counters skip into a critical range (Tx/Rx-Warning, Tx/Rx-Error, Bus-Off) the MSCAN flags an error condition. The status change, which caused the error condition, is indicated by the TSTAT and RSTAT flags (see section **3.3.1.5 MSCAN Receiver Flag Register (CANRFLG)** and **3.3.1.6 MSCAN Receiver Interrupt Enable Register (CANRIER)**).

4.10 Interrupt Acknowledge

Interrupts are directly associated with one or more status flags in either the **3.3.1.5 MSCAN Receiver Flag Register (CANRFLG)** or the **3.3.1.7 MSCAN Transmitter Flag Register (CANTFLG)**. Interrupts are pending as long as one of the corresponding flags is set. The flags in the above registers must be reset within the interrupt handler to handshake the interrupt. The flags are reset by writing a "1" to the corresponding bit position. A flag cannot be cleared if the respective condition still prevails.

NOTE: *It must be guaranteed that the CPU only clears the bit causing the current interrupt. For this reason, bit manipulation instructions (BSET) must not be used to clear interrupt flags. These instructions may cause accidental clearing of interrupt flags which are set after entering the current interrupt service routine.*

4.11 Recovery from STOP or WAIT

The MSCAN can recover from STOP or WAIT via the Wake-Up interrupt. This interrupt can only occur if the MSCAN was in Sleep Mode (SLPRQ=1 and SLPAK=1) before entering Power Down Mode, the wake-up option is enabled (WUPE=1) and the Wake-Up interrupt is enabled (WUPIE=1).

Section 5 Initialization/Application Information

5.1 MSCAN initialization

The procedure to initially start up the MSCAN module out of reset is as follows:

1. Assert CANE
2. Write to the configuration registers in Initialization Mode
3. Clear INTRQ to leave Initialization Mode and enter Normal Mode

If the configuration of registers which are writable in Initialization Mode only needs to be changed when the MSCAN module is in Normal Mode:

1. Make sure that the MSCAN transmission queue gets empty and bring the module into Sleep Mode by asserting SLPRQ and awaiting SLPAK
2. Enter Initialization Mode: Assert INTRQ and await INITAK
3. Write to the configuration registers in Initialization Mode
4. Clear INTRQ to leave Initialization Mode and continue in Normal Mode

Index

-A-

Abort Acknowledge 36
 Abort Request 36
 ABTAK2 - ABTAK0 36
 ABTRQ2 - ABTRQ0 36
 AC7 - AC0 42
 Acceptance Code Bits 42
 Acceptance Mask Bits 44
 address offset 21
 AM7 - AM0 44

-B-

base address 21
 Baud Rate Prescaler 28
 Block Diagram 17
 BOSCH specification 17
 BRP 28
 bus monitoring mode 61
 bus rates 58
 Bus-Off 18, 25, 31, 32, 33, 64, 68

-C-

CAN protocol 17
 CAN Status Change 68
 CAN Status Change Interrupt Enable 33
 CAN Status Change Interrupt Flag 31
 CAN Stops in Wait Mode 24
 CAN system 19
 CANBTR0 25, 27
 CANBTR1 27, 28
 CANCTL0 23, 25
 CANCTL1 25, 27
 CANE 26
 CANIDAC 27, 38
 CANIDAR0-7 27, 41
 CANIDMR0-7 27
 CANRFLG 25, 30
 CARRIER 25, 32
 CANRXERR 40
 CANTAACK 25, 36
 CANTARQ 25, 35
 CANTBSEL 25, 37
 CANTFLG 25, 34
 CANTIER 25, 35
 CANTXERR 40
 CLKSRC 26
 clock 58

clock source 26
 CRC 32
 crystal 59
 CSCIE 33
 CSCIF 31
 CSWAI 24

-D-

Data Length Code bits 48
 data segment register 48
 DB7 - DB0 48
 DLC3 - DLC0 48
 DLR 48

-E-

emulation modes 61
 End of Frame 61
 EOF 61
 error counter 25, 26, 31, 58
 Error Passive 18
 Extended format identifier 47
 extended identifiers 45

-F-

features 18
 FIFO 18, 32, 39, 53, 54, 64, 68

-H-

handshake 25
 hard reset 25

-I-

ID Extended 47
 ID10 - ID0 47
 ID28 - ID0 47
 IDAM1 - IDAM0 38
 IDE 47
 Identifier Acceptance Mode 38
 identifier register 47
 IDHIT2 - IDHIT0 38
 IDR0-3 47
 IFS 52
 INITAK 23, 25, 27
 Initialization Mode 25, 27, 65
 Initialization Mode Acknowledge 27
 Initialization Mode Request 25
 INITRQ 23, 25
 interrupt enable 32
 Interrupt Operation 68

-L-

LISTEN 26
 Listen Only Mode 26
 Listen-Only 61
 local priority 52
 Loop Back Self Test Mode 26
 LOOPB 26

-M-

Memory Map 21
 Motorola Scalable Controller Area Network 17
 MSCAN 17
 MSCAN Clock Source 26
 MSCAN Enable 26
 MSCAN12 17

-N-

normal modes 61

-O-

Overrun 68
 overrun 32
 Overrun Interrupt Flag 32
 OVRIF 32

-P-

PHASE_SEG1 59
 PHASE_SEG2 59
 PLL 59
 Power Down Mode 66
 power saving 24, 62
 prescaler 59
 PROP_SEG 59

-R-

REC 31
 Receive Buffer Full Flag 32
 Receive Error Counter 31, 40
 Received Frame Flag 23
 Receiver Active Status 23
 Receiver Input Pin 19
 Receiver Status Bits 31
 register map 21
 Remote Transmission Request 47
 Reserved Registers 39
 reset 67
 RSTAT1, RSTAT0 31
 RSTATE1, RSTATE0 33
 RTR 47
 run mode 23, 62

RXACT 23
 RXCAN 19
 RXFRM 23

-S-

SAMP 29
 sample point 29
 Sampling 29
 security 62
 SJW1, SJW0 27
 Sleep Mode 24, 27, 63, 64, 65, 66, 67, 68, 69
 Sleep Mode Acknowledge 27
 Sleep Mode Request 24
 SLPRQ 23, 24
 SOF 48
 special modes 61
 SRR 47
 Standard format identifie 47
 standard identifiers 45
 Start of Frame 48
 STOP 24, 69
 Stop Mode 63
 Substitute Remote Request 47
 SYNC_SEG 59
 SYNCH 24
 Synchronization Jump Width 27, 60
 Synchronized Status 24

-T-

TBPR 44, 48
 TEC 31
 TIME 24, 49
 Time Segment 1 29, 59
 Time Segment 2 29, 59
 time stamp 61
 Time Stamp register 44
 Timer Enable 24
 transceiver 19
 Transmit Buffer Priority Register 44
 Transmit Buffer Select 37
 Transmit Error Counter 31, 40
 Transmitter Output Pin 19
 TSEG1 59
 TSEG13 - TSEG10 29
 TSEG2 59
 TSEG22 - TSEG20 29
 TSRH, TSRL 49
 TSTAT1, TSTAT0 31
 TXCAN 19

-W-

WAIT 24, 69

Wait Mode 63
wake-up 33
Wake-Up Enable 24
Wake-Up Function 67
Wake-up Interrupt Enable 33
Wake-up Interrupt Flag 31
Warning 18
warning condition 68
WUPE 23, 24
WUPIE 24
WUPIF 31
WUPM 26

Block Guide End Sheet

**FINAL PAGE OF
76
PAGES**