

Directed Depth First Search

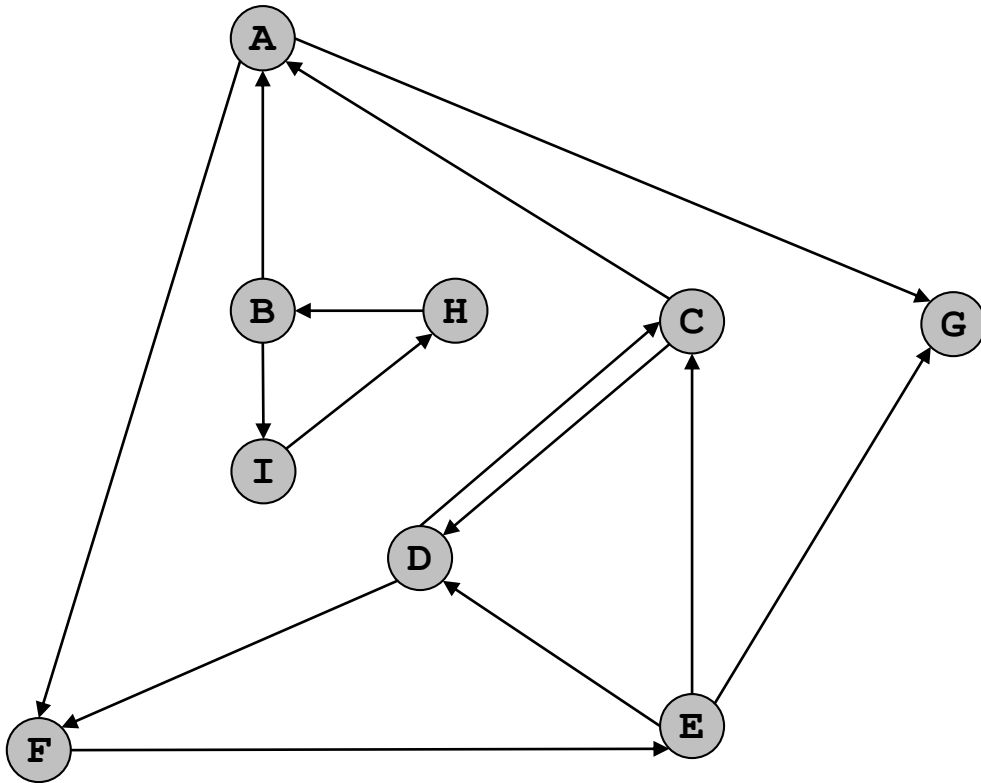

Adjacency Lists

A: F G
B: A H
C: A D
D: C F
E: C D G
F: E
G:
H: B
I: H

Directed Depth First Search

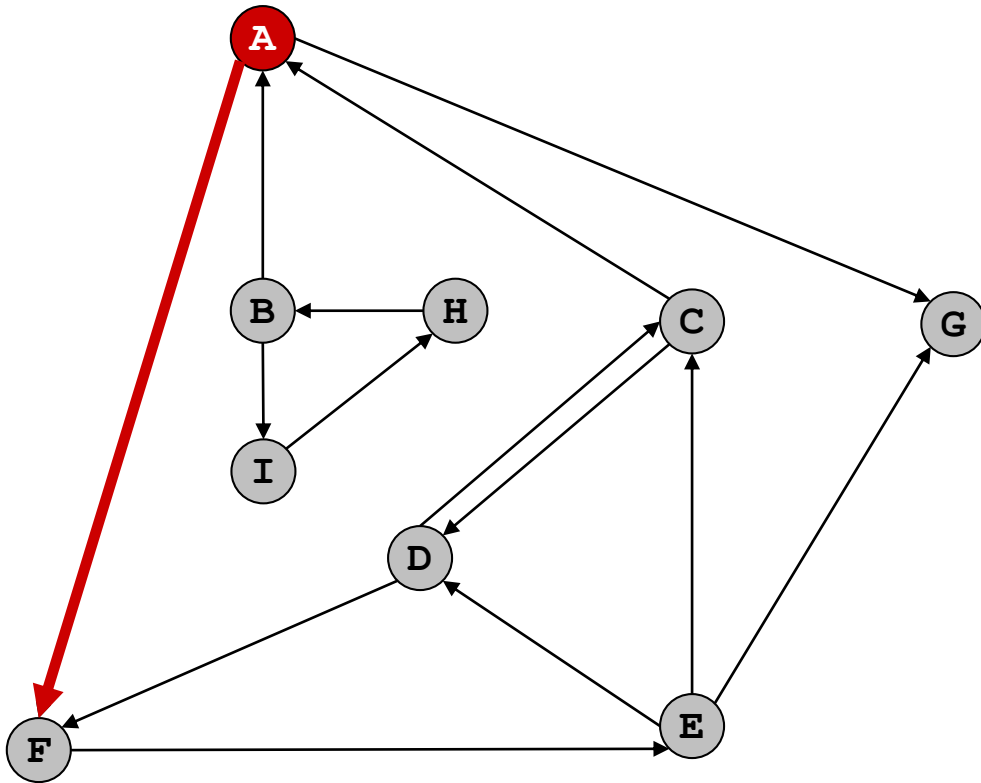

Function call stack:

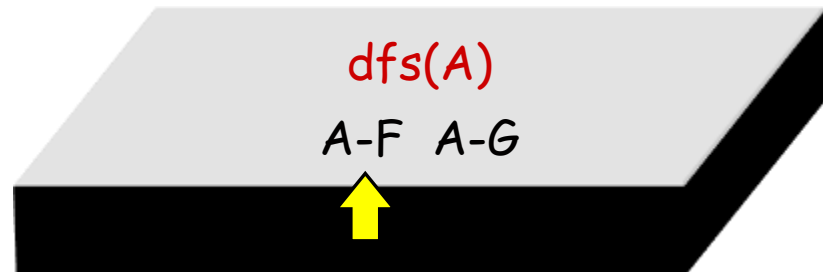

Directed Depth First Search

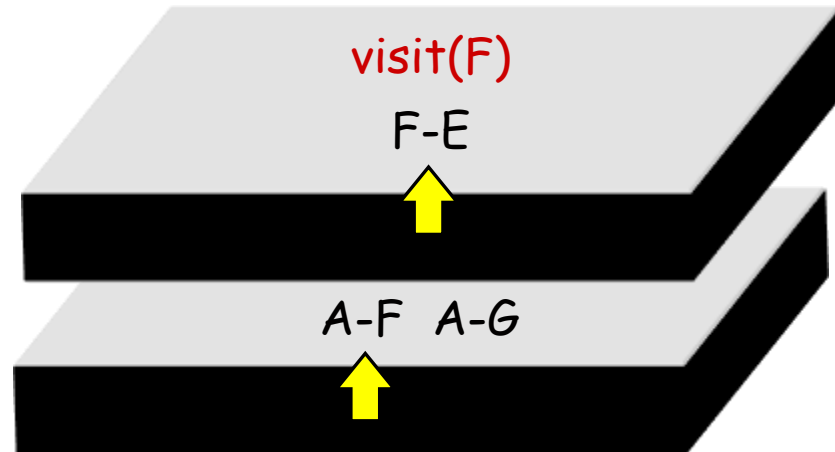
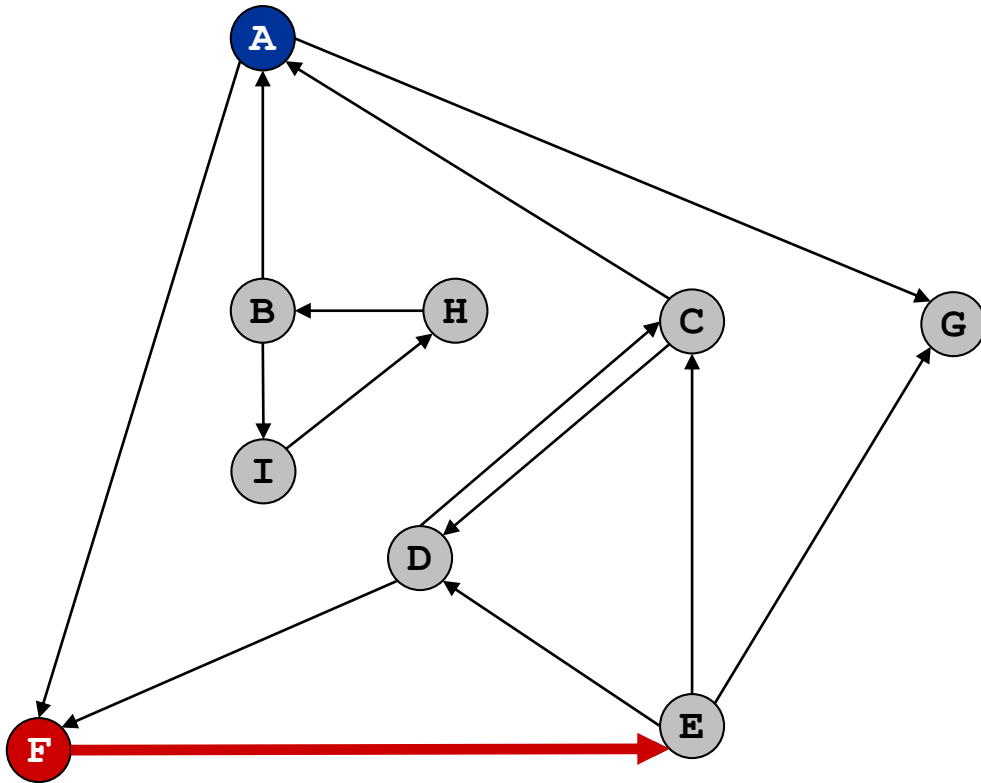

Function call stack:

Directed Depth First Search

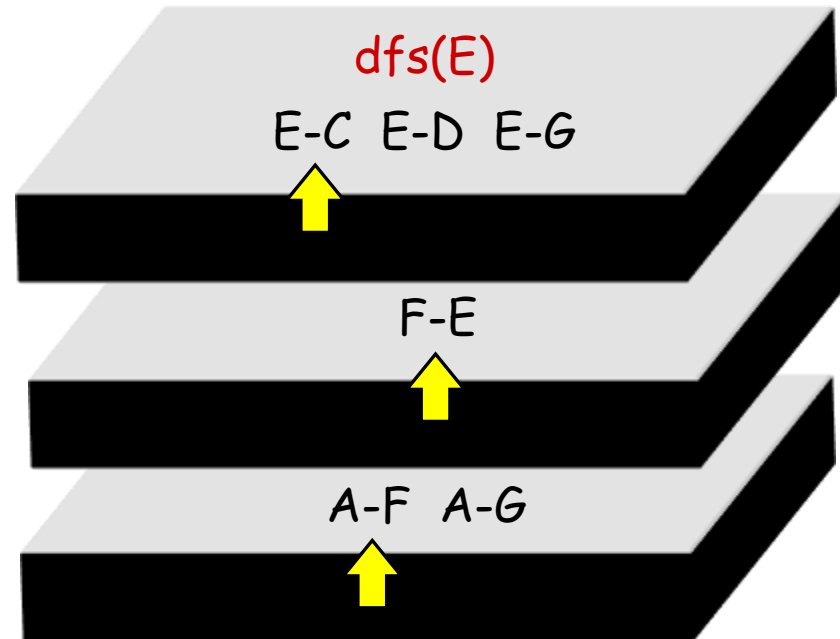
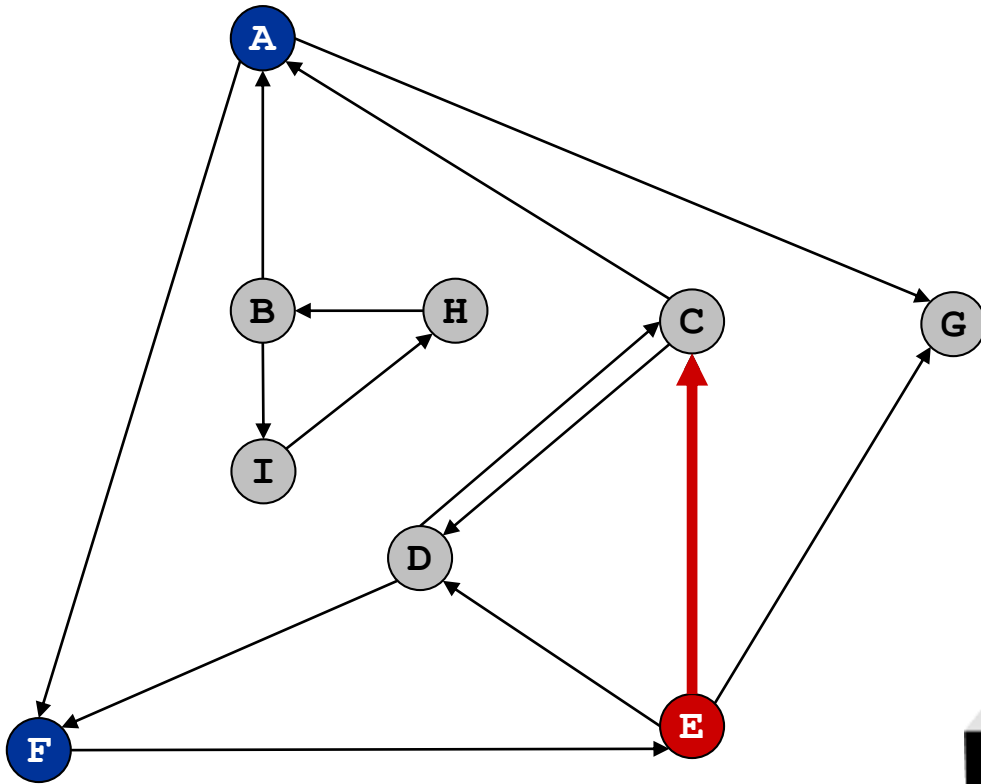

Function call stack:

Directed Depth First Search

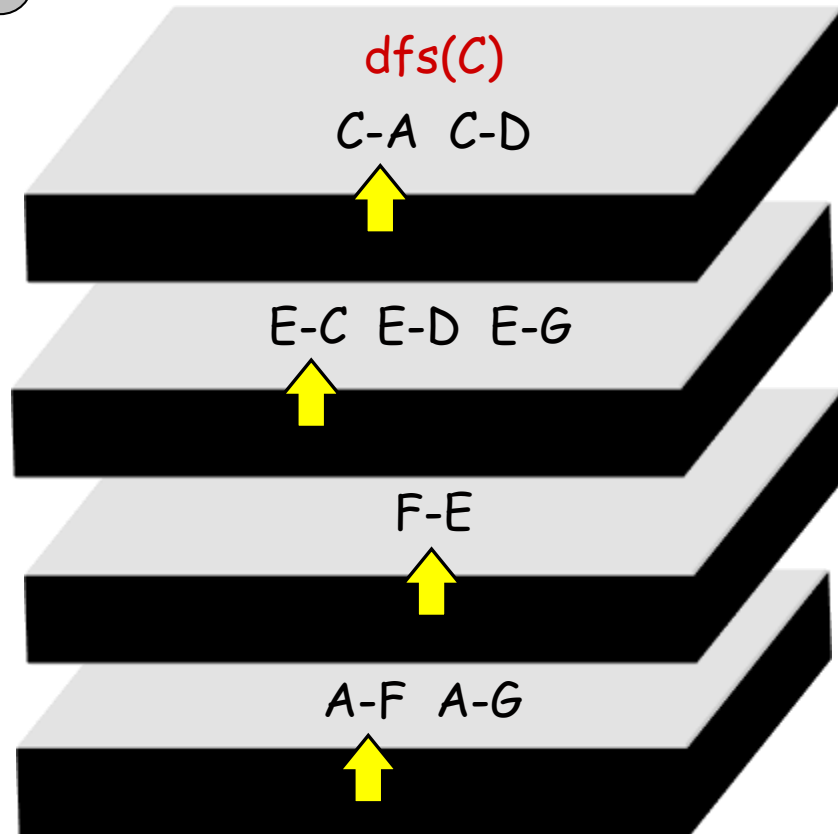
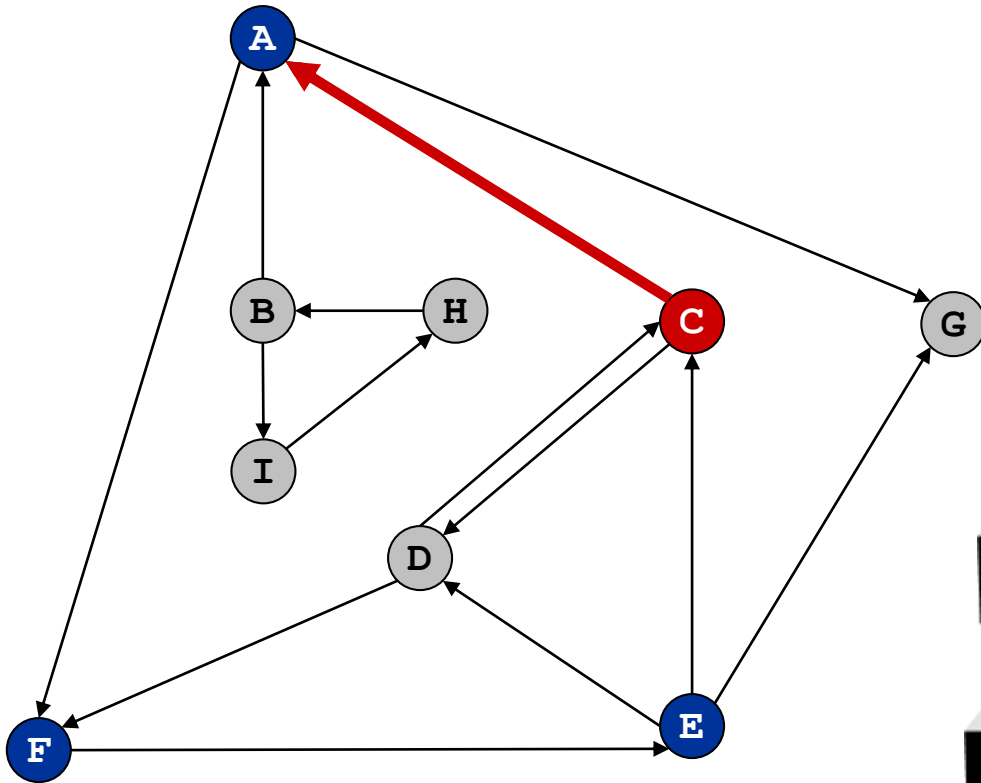

Function call stack:

Directed Depth First Search

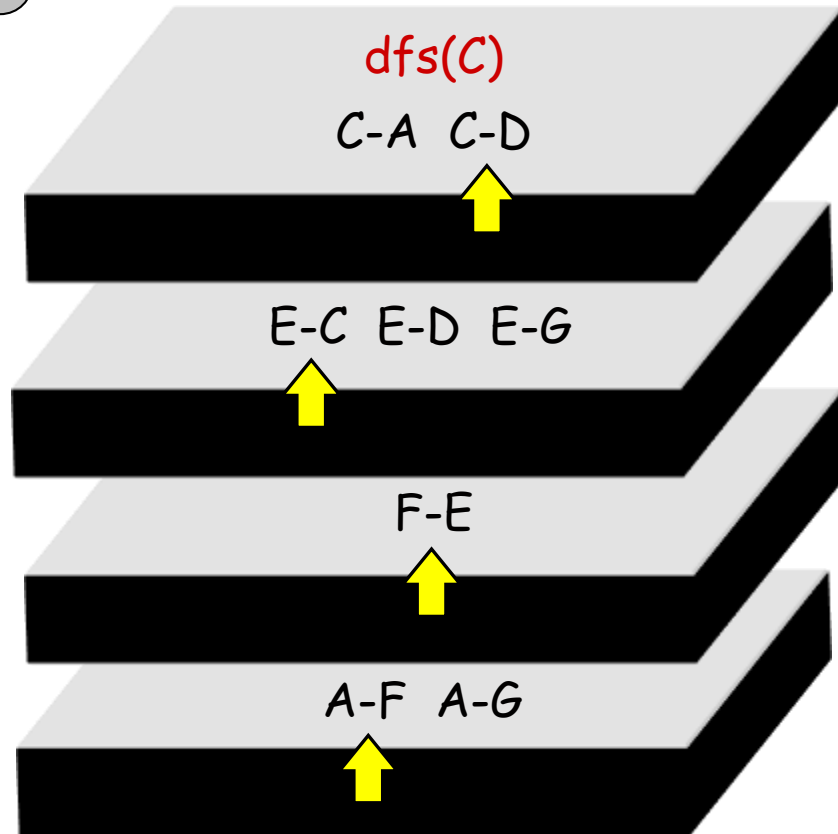
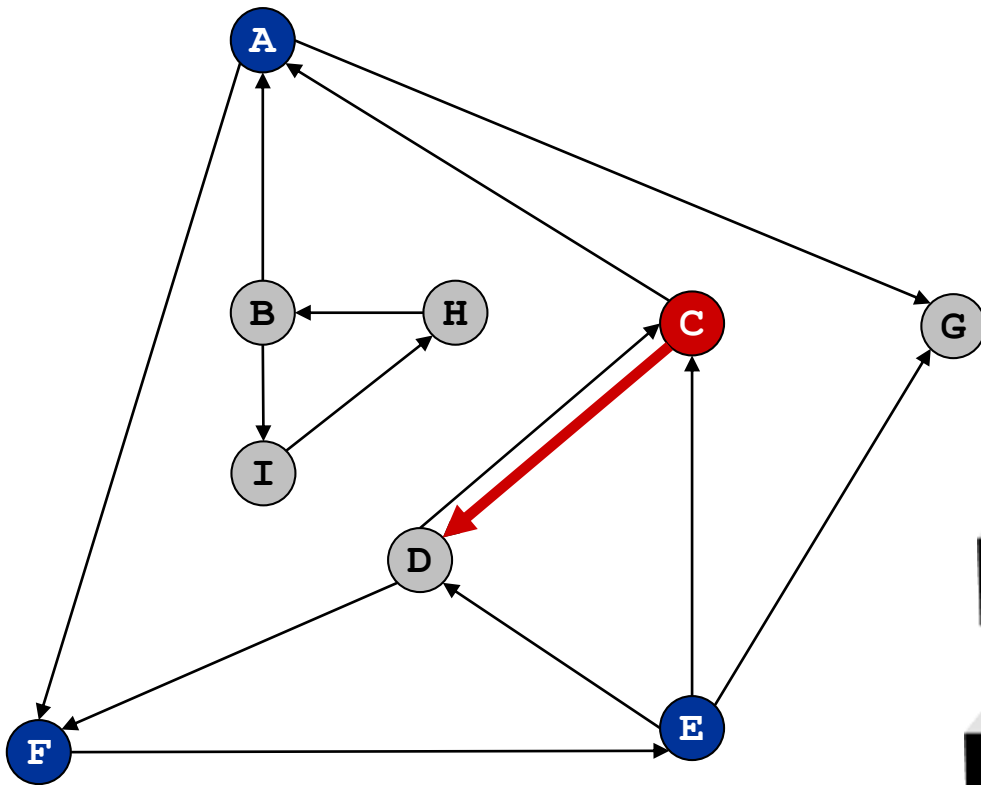

Function call stack:

Directed Depth First Search

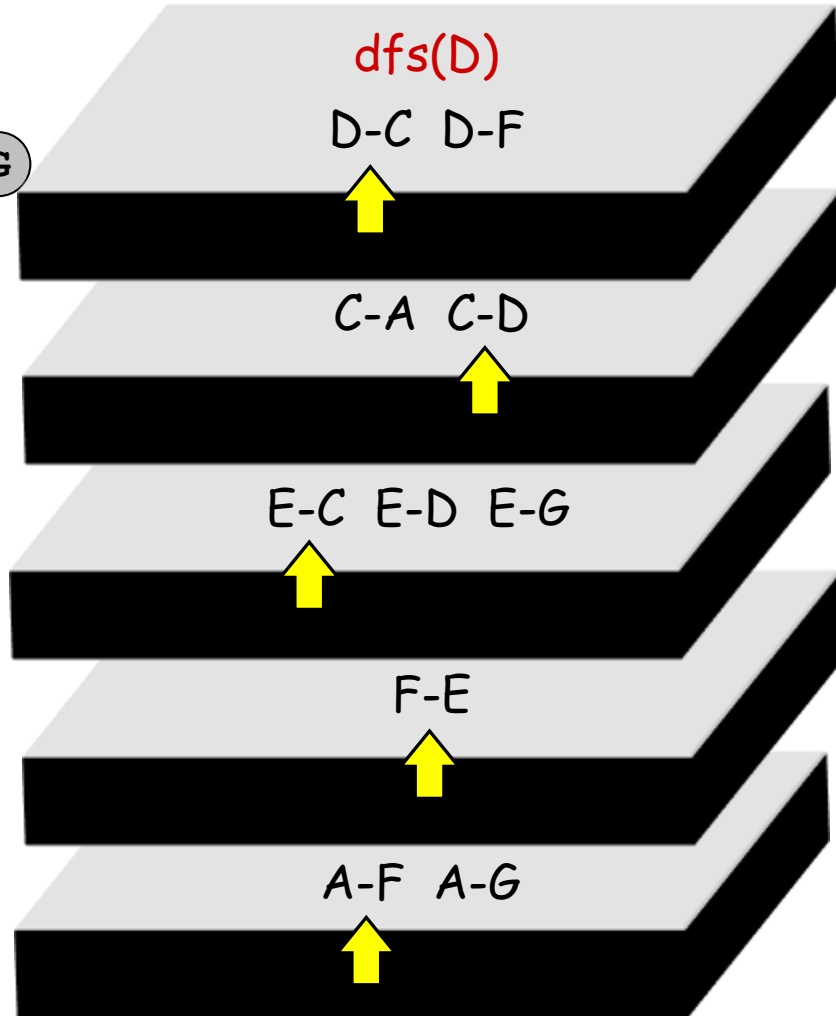
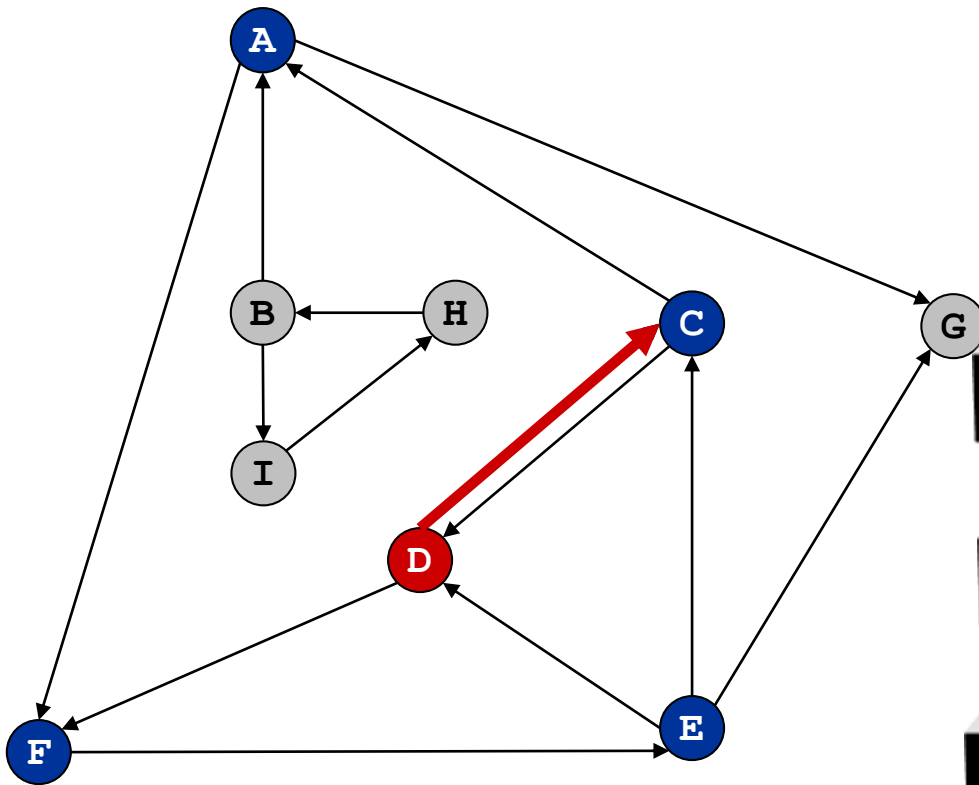

Function call stack:

Directed Depth First Search

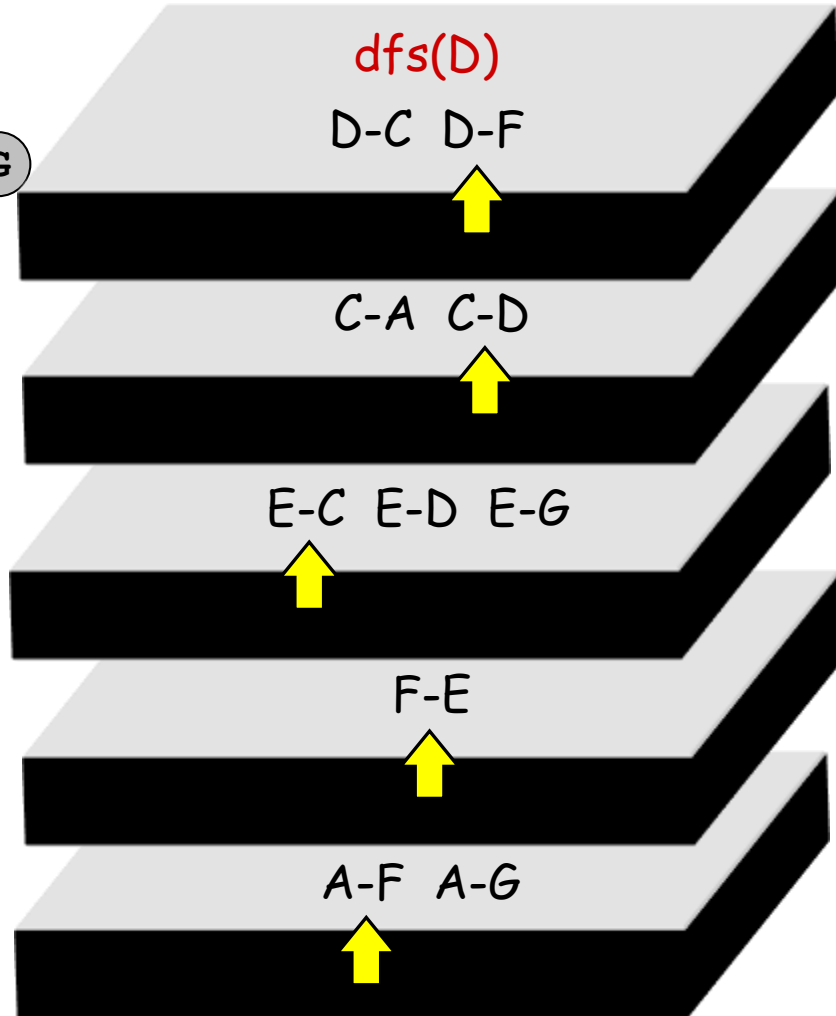
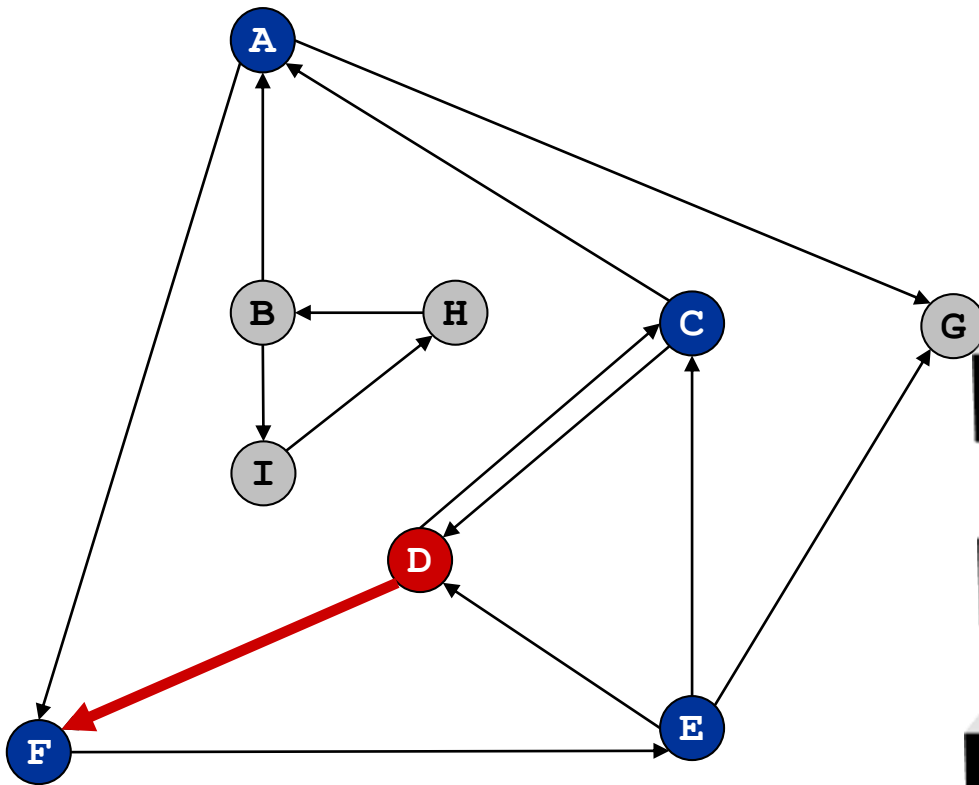

Function call stack:

Directed Depth First Search

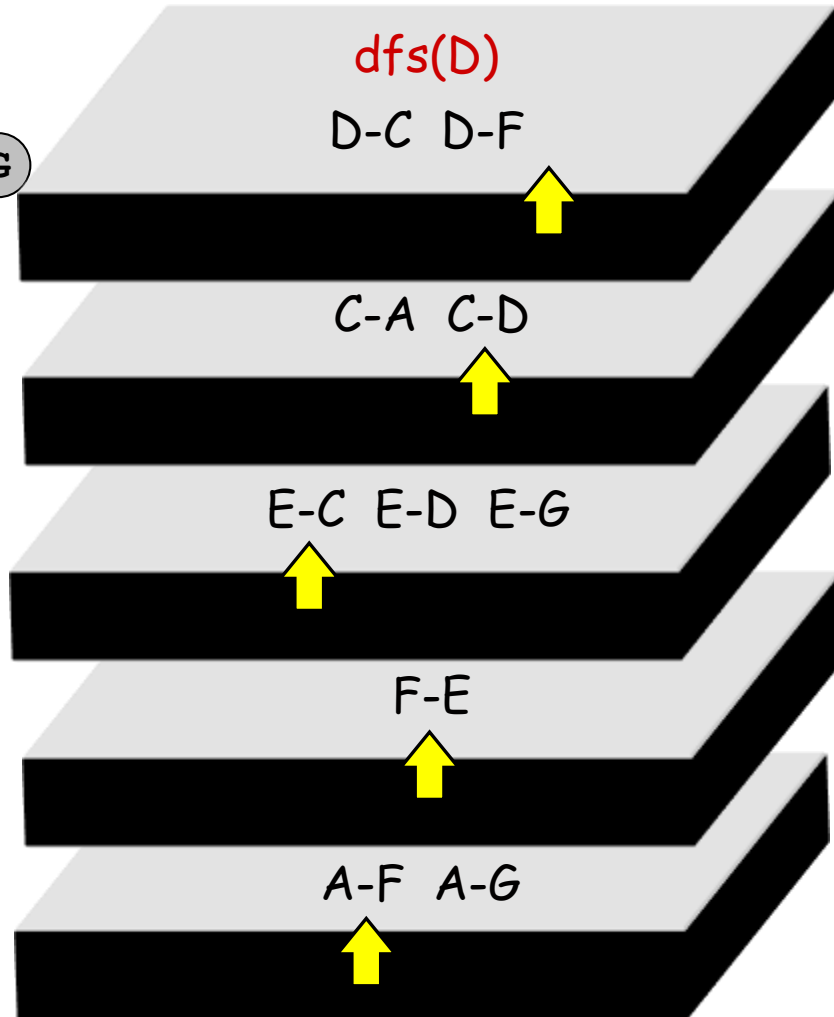
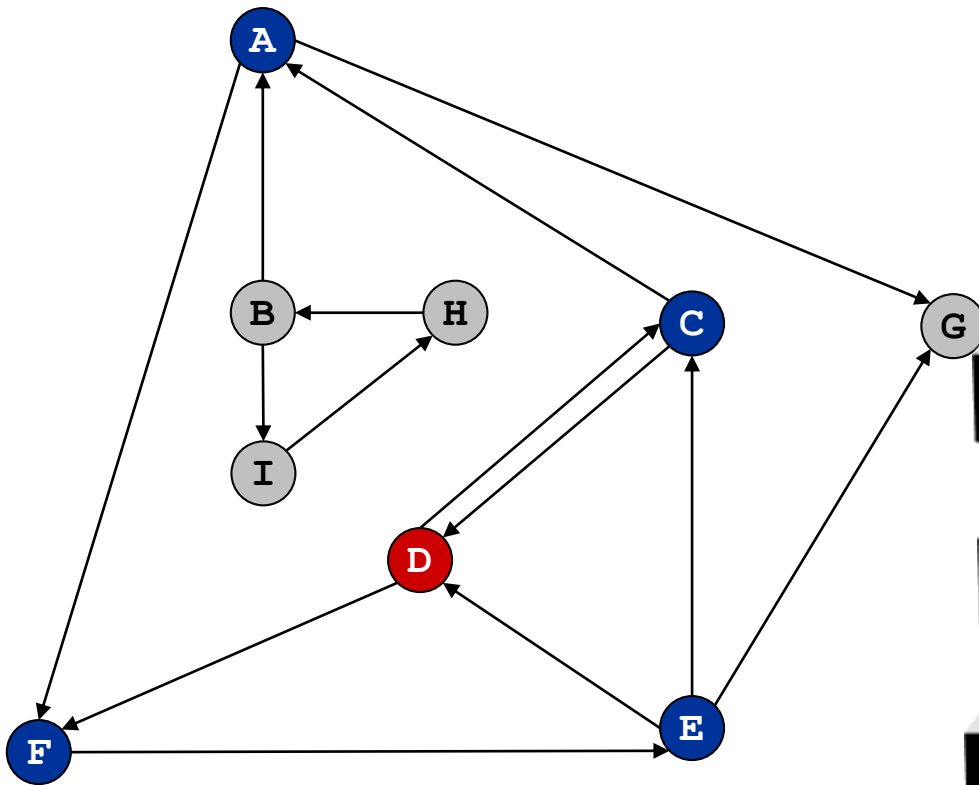

Function call stack:

Directed Depth First Search

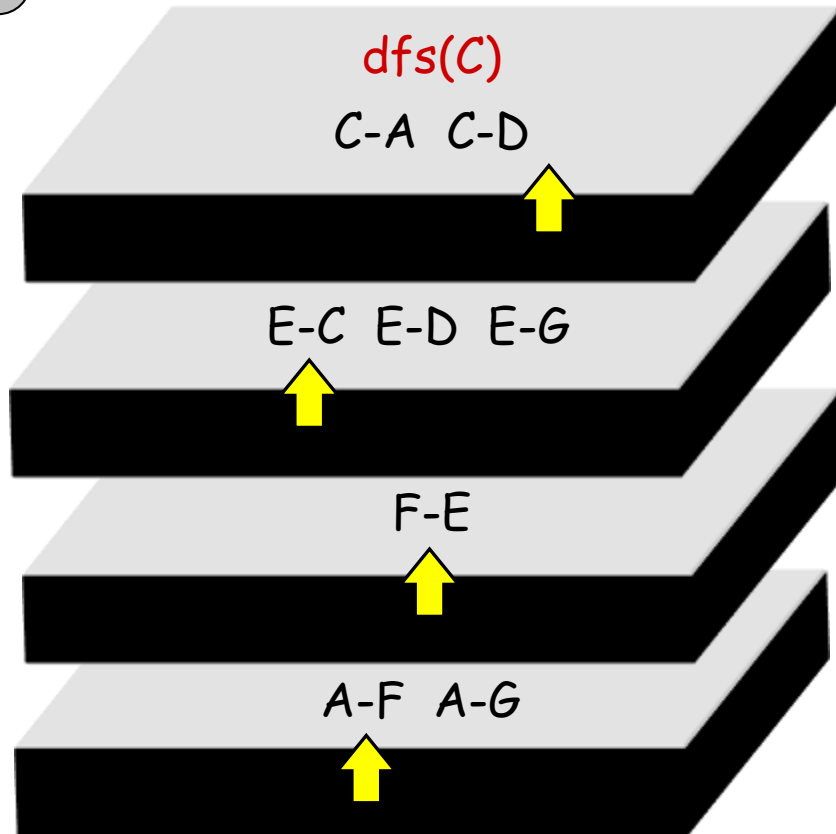
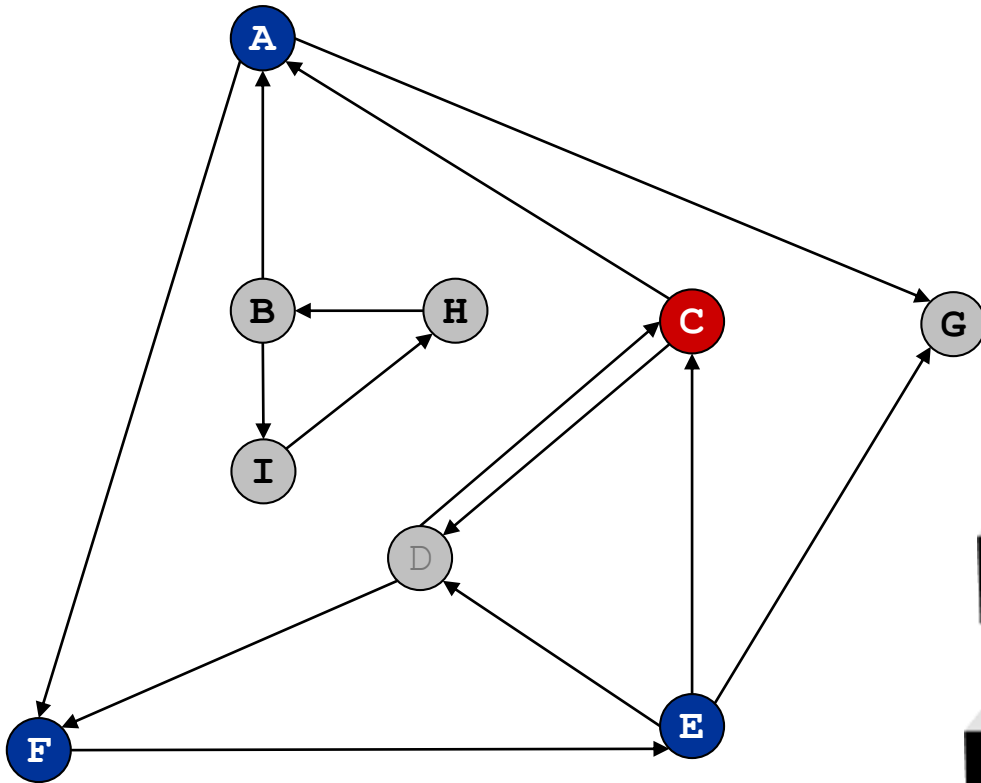

Function call stack:

Directed Depth First Search

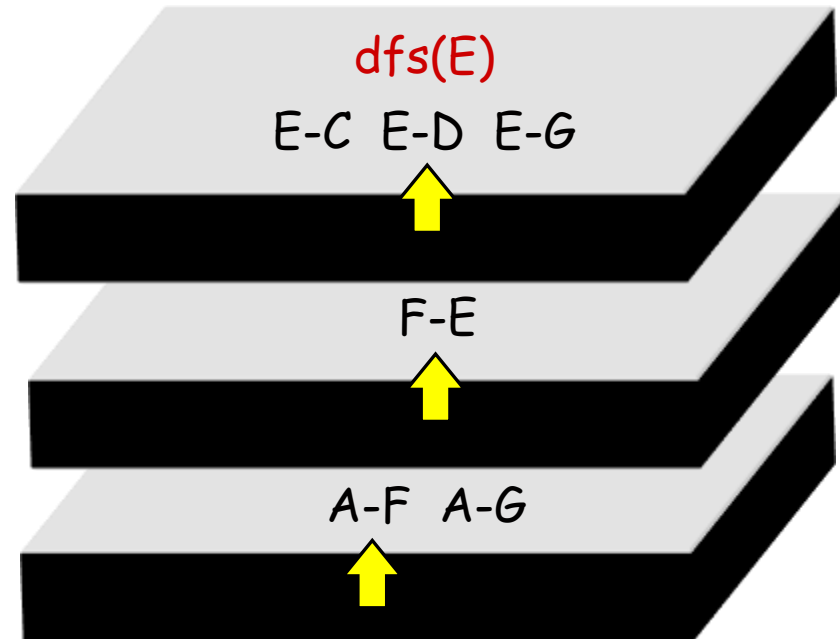
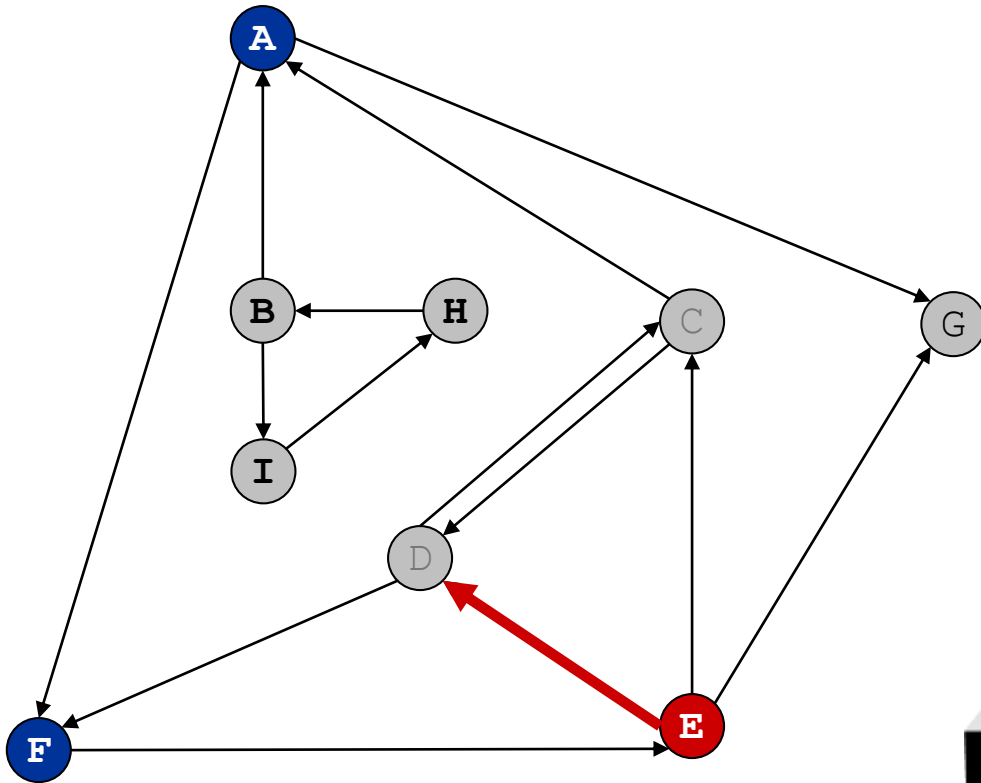

Function call stack:

Directed Depth First Search

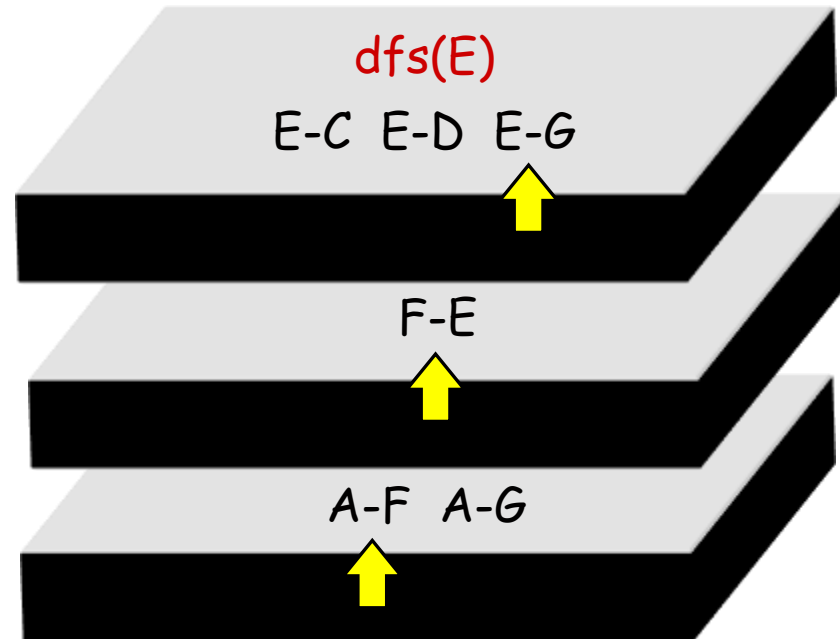
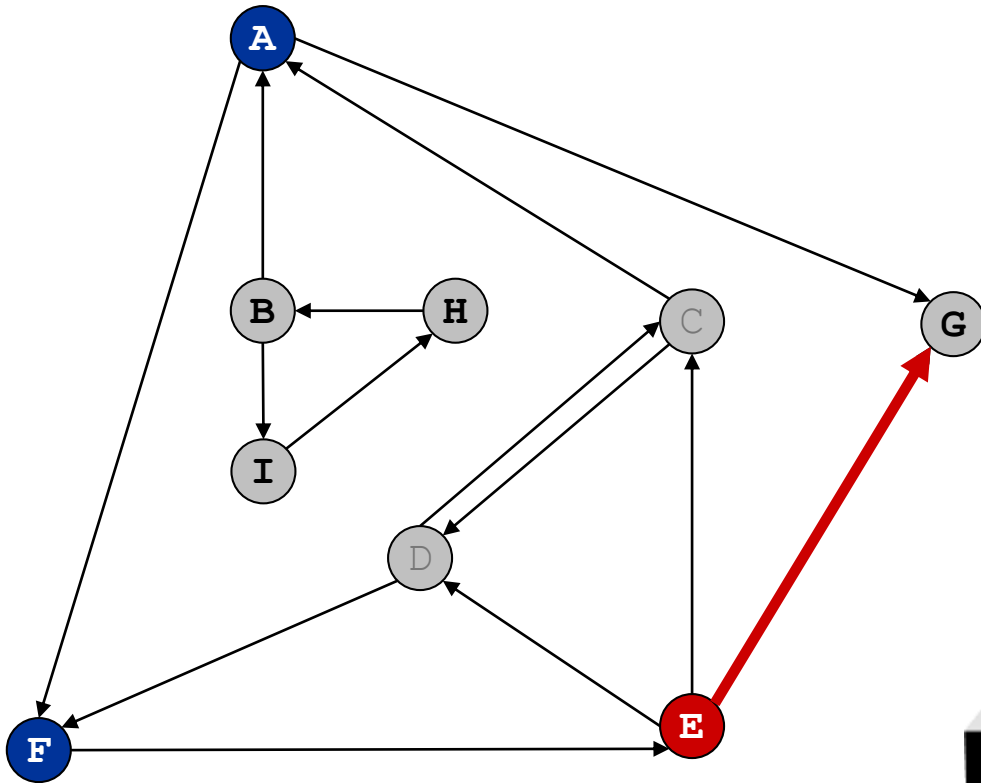

Function call stack:

Directed Depth First Search

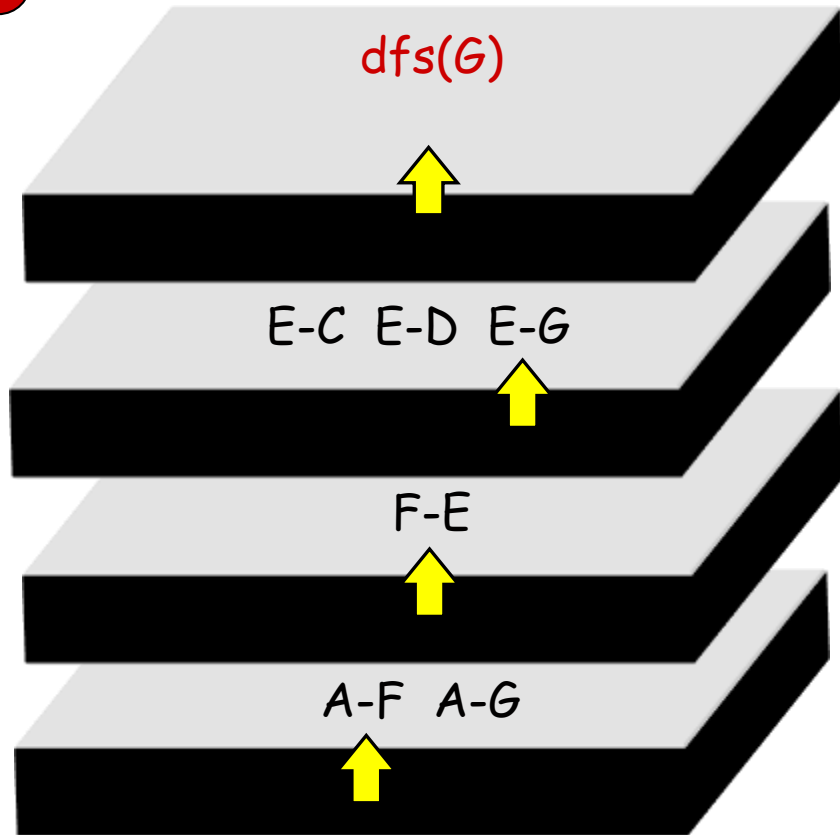
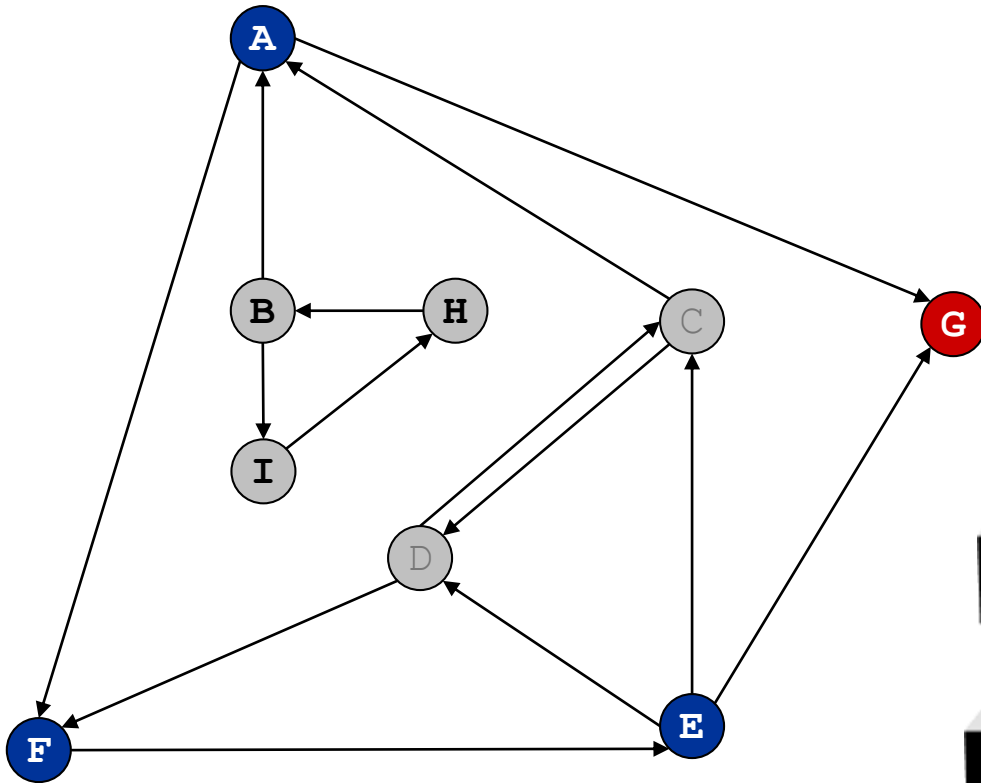

Function call stack:

Directed Depth First Search

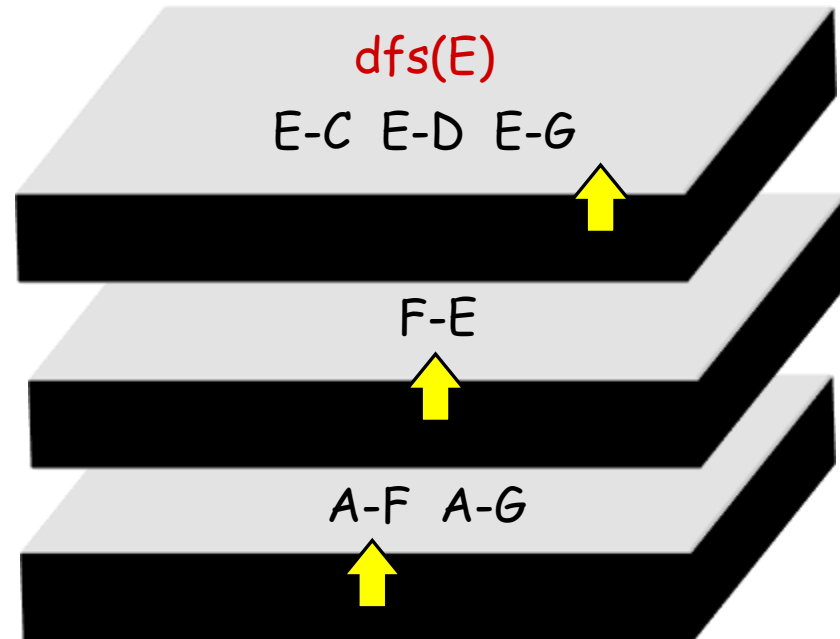
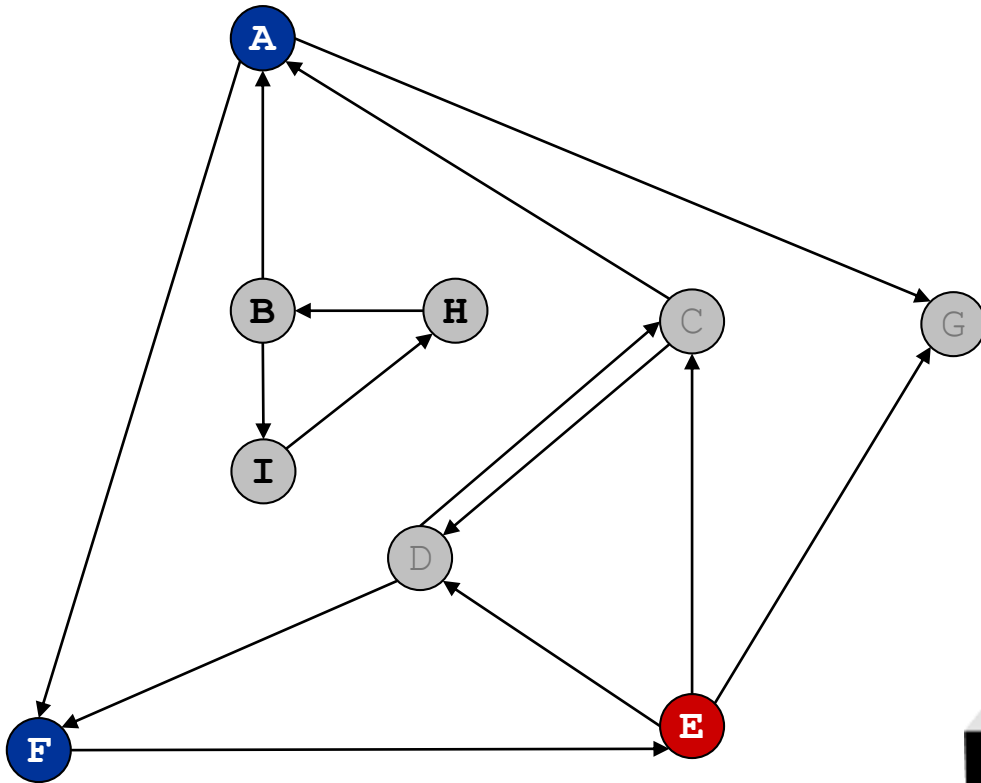

Function call stack:

Directed Depth First Search

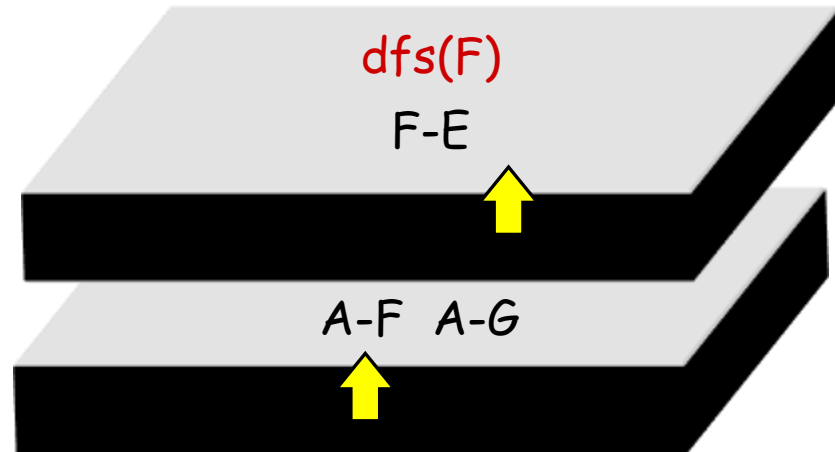
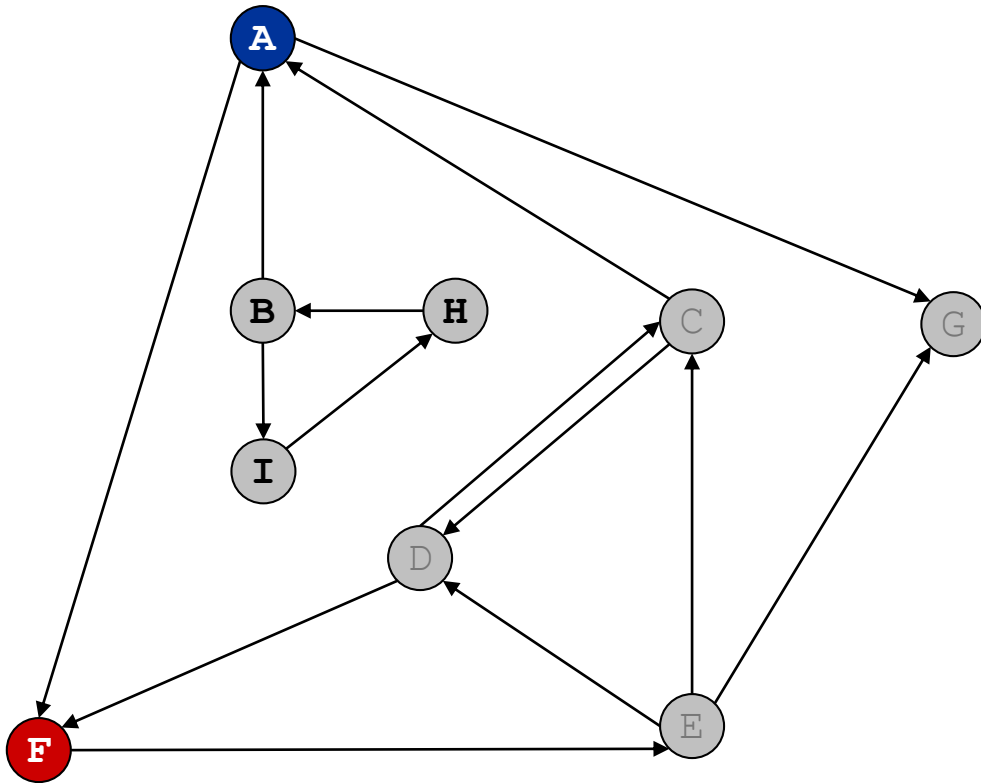

Function call stack:

Directed Depth First Search

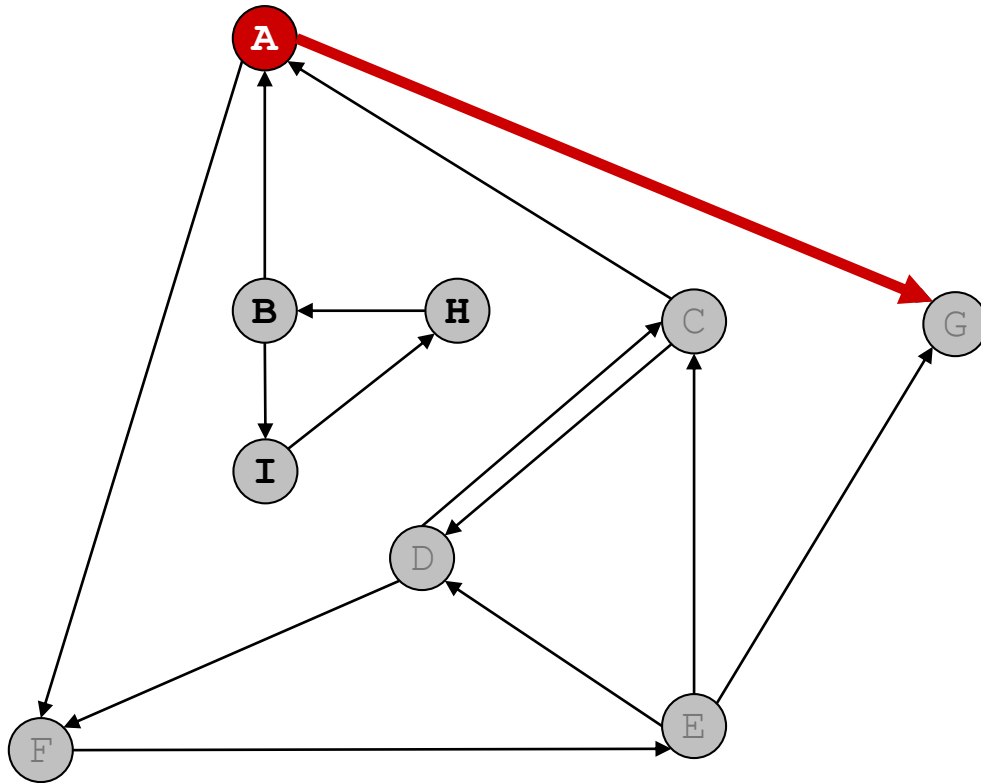

Function call stack:

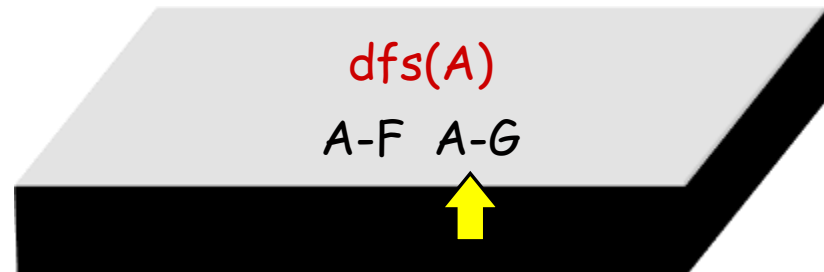

Directed Depth First Search

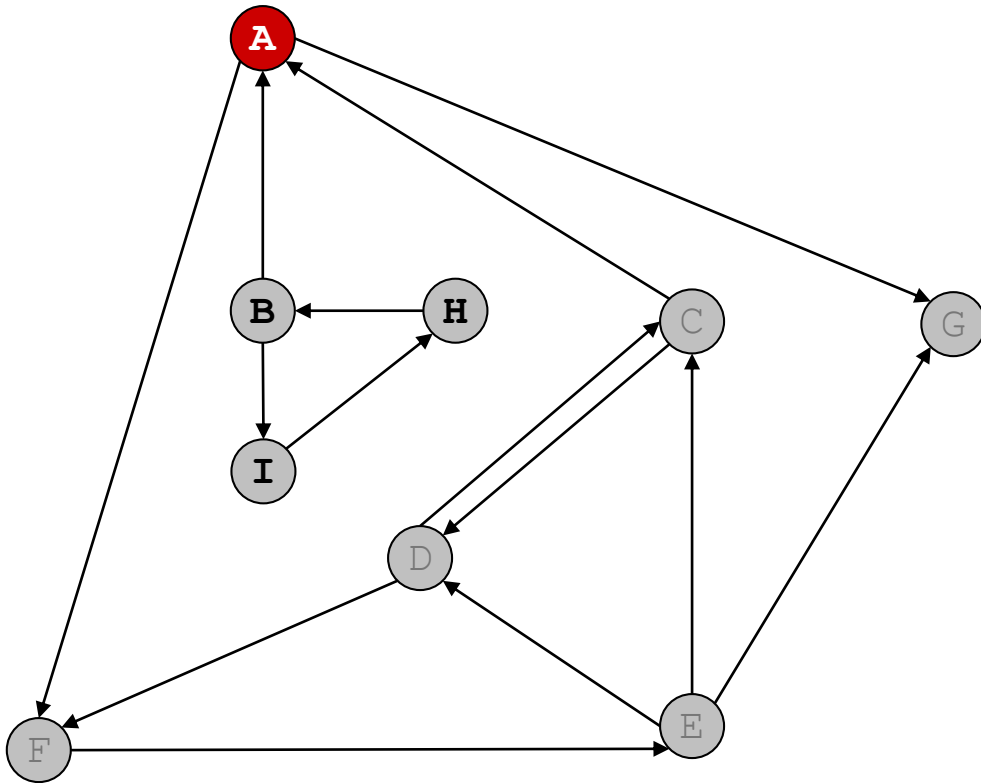

Function call stack:



Directed Depth First Search

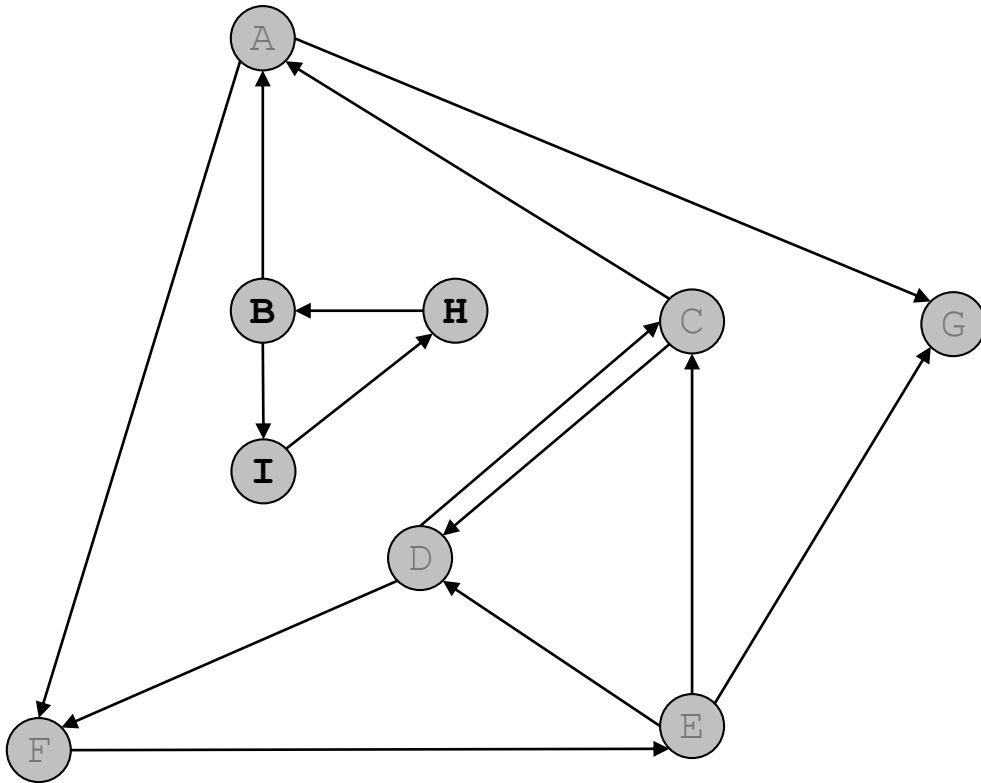

Nodes reachable from A: A, C, D, E, F, G