

Feasibility Analysis of Inter-Pulse Intervals Based Solutions for Cryptographic Token Generation by Two Electrocardiogram Sensors

Lara Ortiz-Martin^b, Pablo Picazo-Sanchez^{a,*}, Pedro Peris-Lopez^b, Juan Tapiador^b, Gerardo Schneider^a

^a*Chalmers | University of Gothenburg, Sweden.*

^b*Universidad Carlos III de Madrid, Spain.*

Abstract

In this paper we address the problem of how two devices that are sensing the same heart signal can generate the same cryptographic token by extracting them from the Inter-Pulse Intervals (IPIs) of each cardiac signal. Our analysis is based on the use of a run-time monitor, which is extracted from a formal model and verified against predefined properties, combined with a fuzzy extractor to improve the final result. We first show that it is impossible, in general, to correct the differences between the IPIs derived from two captured electrocardiogram (ECG) signals when using only error correction techniques, thus being impossible to corroborate previous claims on the feasibility of this approach. Then, we provide a large-scale evaluation of the proposed method (run-time monitor and fuzzy extractor) over 19 public databases from the Physionet repository containing heart signals. The results clearly show the practicality of our proposal achieving a 91% of synchronization probability for healthy individuals. Additionally, we also conduct an experiment to check how long the sensors should record the heart signal in order to generate tokens of 32, 64 and 128 bits. Contrarily to what it is usually assumed (6, 12, and 24 seconds for individuals with a heart rate of 80 beats-per-minute), the sensors have to wait 13, 28 and 56.5 seconds on median, respectively, to derive the same token from both sensor

Keywords: Biometrics, Security, Privacy, Body Sensor Networks

*Corresponding author

Email addresses: laortizm@inf.uc3m.es (Lara Ortiz-Martin), pablop@chalmers.se (Pablo Picazo-Sanchez), pperis@inf.uc3m.es (Pedro Peris-Lopez), jestevez@inf.uc3m.es (Juan Tapiador), gersch@chalmers.se (Gerardo Schneider)

This work was partially supported by the Spanish CAM grant S2013/ICE-3095 (CIBER-DINE), the Spanish MINECO grant TIN2016-79095-C2-2-R (SMOG-DEV), and, by the Swedish Research Council (Vetenskapsrådet) under grant Nr. 2015-04154 (PolUser: Rich User-Controlled Privacy Policies).

1. Introduction

Interest in biometrics has gained momentum in the last years mostly due to the massive use of daily life devices like smartwatches, smartphones and laptops [1, 2]. This technology identifies and authenticates people in an automatic way based on biological and behavioral traits [3]. This interest is not temporary. According to a recently published report, global biometric market revenues will reach \$34.6 billion annually in 2020, especially in mobile devices [4].

From a technical point of view, biometrics can be classified into two main groups depending on whether they use physiological or behavioral signals. Examples of physiological signals include fingerprints, iris, retina, heart and brain signals, whereas voice, signature analysis or keystroke dynamics are behavioral signals. The main reason why such signals can be easily included in authentication systems is because they exhibit a number of desirable features: they are universal, collectible, unobtrusive, permanent, unique, and difficult to circumvent [5].

The research outcome in this area is that most gadgets, such as smartphones, tablets, wearables and *Implantable Medical Devices (IMDs)*, have been equipped with one or more embedded sensors with the ability to measure biometric parameters from the bearer. Besides having biometrics sensors, most (if not all) of these devices are enhanced with some wireless communication technology, e.g., Bluetooth, WiFi or *Radio Frequency (RF)*, allowing them to share data and to perform remote reconfiguration [6]. All the above has given birth to the so-called *Wireless Body Area Network (WBAN)*.

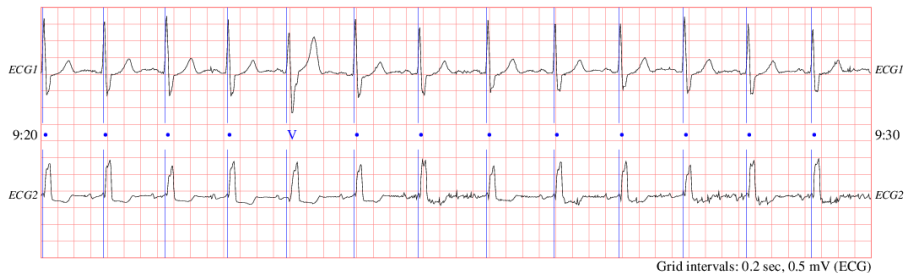

Figure 1: Two ECG signals from svdb [7] database.

In the last years, several works have focused on using the heart signal as part of either authentication protocols [8, 9, 10], human identification [11, 12], or as a key generation algorithm [13, 14, 15, 16] to enable secure communications. More concretely, authors use the *Electrocardiogram (ECG)* to extract the time difference between two consecutive heartbeats (R-peaks). These time intervals are referred to as *Inter-Pulse Intervals (IPIs)* or RR-intervals and have been shown to contain some degree of entropy after applying a quantization algorithm (see Section 3.2.1). This makes the IPI values an ideal candidate to generate tokens to be used in cryptographic solutions (e.g., [8, 10, 17, 18, 19]).

In order to obtain a biometric signature based on the heart signal, different sensors such as ECG, *Photoplethysmographic (PPG)* or *Blood Pressure (BP)* can be used. The ECG signal is measured using electrodes usually placed on the chest which detect the tiny electrical changes in the heart and generate a complex digital signal. The PPG detects the pulse of the heart by measuring the amount of light which is reflected in the skin to a photodiode. As a light source, most of the commercial gadgets have a LED on them, e.g., smartwatches and sport wrists. As an example on how these advances may be used for new purposes, some researchers have recently used a BP sensor to get the bearer’s heart signal [10]: this sensor can measure the pressure in large arteries in the systemic circulation, so the signal reflects the up and down fluctuation of the arterial pressure which is related to each heartbeat.

Using these sensors is not trivial though, as there are some technical difficulties due to different factors. For example, even when two similar sensors—from the same manufacturer, having the same brand, and with the same capabilities—are measuring the same heart signal in the same part of the body, the resulting signal would likely be different in both sensors due to the noise of the signals, missed data during the gathering phase, delays, or simply because of the bearer’s movements [20].

Along the same lines, it has been reported in [21] that both *Heart-Rate Variability (HRV)* and *Inter-Sensor Variability (VAR_{is})* measurements directly affect the processing of the heart signal and, in particular, the peak detection procedure. These issues become crucial when a cryptographic protocol entirely relies on biometric data acquisition to generate random tokens, e.g., random seeds or fresh nonces, to be used for key generation [22] or in authentication procedures [8].

In particular, the problem of signal synchronization is quite relevant in the health sector where expensive medical electrodes are used. Let us consider a real example of measuring ECGs using two different sensors. Figure 1 shows two ECG signals, channel 1 (ECG_1) and channel 2 (ECG_2), taken from the public database *svdb* [7]. This database is composed of 78 half-hour ECG recordings of supraventricular arrhythmias. The *beats per minute (bpm)* in both signals are the same, or, in the worst case, show a difference of a few bpm. However, at low level, the time differences between two consecutive heartbeats (R-peaks), are slightly different in ECG_1 and ECG_2 . Thus, despite sensing the same ECG from the same patient, both channels have different signals, and it is easy to see that even by shifting any of the signals it could not be possible to fully synchronize them.

Authors are somehow aware of this problem and for instance in [20], a miss-detection algorithm is proposed that given two ECGs, authors “manually” add a peak in the place where it was supposed to be whenever it is detected that a peak was missing in order to generate the same token in different devices. Some years later, in [23], authors propose a key-exchange protocol among a Programmer²

²Device used to (re)configure IMDs.

and an IMD where both devices generate the same key from the heart signal. After gathering the same signal, authors apply a *Bose-Chaudhuri-Hocquenghem (BCH)*, which is an *Error Correcting Code (ECC)*, to the generated keys in both devices to finally get the same value.

80 *1.1. Our Work*

No matter if authentication protocols for WBAN were published [8, 11, 24], if key distribution schemes based on the heart signals were proposed [9, 23] or whether authors assumed that there is a secure communication channel and a shared key is derived from the heart signal to be used afterwards in a cryptographic protocol [10, 13, 20, 25], all these proposals rely on the same assumption: 85 there are two sensors measuring the heart signal and they can derive the same cryptographic token under an IPI-based approach and after applying an ECC algorithm like BCH. Unfortunately, after an in depth analysis (19 databases), we show that the above claim does not hold when only an ECC algorithm is 90 used to correct errors between the two generated tokens.

Motivated by this, we carry out an analysis on the (open) question concerning the generation of a cryptographic token based on the analysis of IPI values from different ECG devices that are sensing the same heart signal. Our analysis is based on the use of a run-time monitor, extracted from a formal model, i.e., a 95 timed automaton, that is verified against predefined properties, combined with a fuzzy extractor (i.e., an ECC) to improve the final result. We show that it is impossible, in general, to correct the differences between the two captured signals when using only the fuzzy extractor, thus being impossible to corroborate previous claims on the feasibility of the approach.

100 Our proposed method can successfully synchronize two heart signals through IPI values and extract a common token that can be used afterwards as part of a cryptographic protocol, as one more security check in order to proof that both devices are attached to the same body by proving that they are listening to the same heart signal, i.e., they are attached to the same body.

105 To the best of our knowledge, this is the first work to use a run-time monitor in combination with a fuzzy extractor. In addition, to demonstrate the validity of our approach, we provide a large-scale evaluation of the proposed method over 19 public databases containing heart signals. However, we do not evaluate how good or bad the IPI-based generated random tokens are from a cryptographic 110 point of view; we urge the reader to consult [26] for an in-depth analysis of this issue.

After applying our proposed solution to public databases containing at least two measurements of heart signals (ECG_1 and ECG_2), we conclude that a fuzzy extractor (or another error correction technique) is not enough to correct the 115 synchronization errors between the IPI values derived from two ECG signals captured via two sensors placed on different positions (Section 3). In particular, we show that a pre-processing of the heart signal must be performed before the fuzzy extractor is applied.

1.2. Contributions

120 In summary, our contributions are:

- We perform an in-depth analysis of the problem of how to synchronize two cryptographic tokens generated by two different ECG sensors that record the same heart signal and use the IPIs as the basics for generating the mentioned tokens. We show how an initial signal pre-processing step is necessary for the error correction algorithm (e.g., fuzzy extractor) to work properly. Our results show that it is not possible to assume that two sensors can derive a common token just by applying an error correction algorithm without having previously synchronized both signals. In summary, this first result gives evidence that the assumptions under which previous IPI-based solutions operate are not correct and does not guarantee that the same token can be extracted from two ECGs sensors (Section 3.2).
125
- In order to perform the synchronization (at IPI values level) between two ECGs sensors, we have generated a run-time monitor from a timed automaton, which has been verified correct with respect to predefined timing properties. We compare our results before and after applying a fuzzy extractor and demonstrate our improvement in performance (Section 3.3).
135
- We modified our timed automaton and the monitor in order to extract a token with a given accuracy (namely 32, 64 and 128 bits), in order to gather statistical information on how long it would take (median) to get a token with the requested accuracy. We found that to generate a 32, 64 and 128 bits tokens, a sensor should wait on median 13, 28 and 56.5 seconds, respectively (for individual with a heart rate of 80 beats-per-minute), instead of 6, 12, and 24 seconds as reported in previous works, i.e., [8, 11, 27, 28] (Section 3.3.2).
140
145
- We have developed a proof-of-concept implementation of an ECG-based token generator by using a BITalino shield³ (Section 4). This shield has two ECG channels connected using wires and the pre-processing is executed before the token generation (IPI-based approach in our particular case) takes place. The purpose of this proof-of-concept is to shed further light on the technical real difficulties in getting a fully working implementation of such a solution.
150
- As it was previously stated, the contributions in this article shed light on the feasibility of IPI-based solutions, where two sensors obtain such values from the same organ (in our case the heart). On the other hand, in this article we do not analyze the security of IPI values, which has been widely studied in the literature (e.g., [8, 10, 26, 18]).
155

³<http://bitalino.com/en/>

1.3. Organization

The rest of this paper is organized as follows, in Section 2 we provide some
160 basic knowledge in order to facilitate the reading of the rest of the paper. Section
3 presents the core of our work, while Section 4 introduces our proof-of-concept
implementation of the proposed solution. Section 5 contains a summary of the
main published papers in this research area. Finally, we conclude and present
future directions for further research in the last Section.

165 2. Background

In this section we provide some preliminaries on *Body Area Networks (BANs)*
and we give a brief overview of the datasets used for the experiments. After this,
we yield an overview of related work that has explored how heart signals can be
applied to biometrics and cryptography. We also discuss why fuzzy extractors
170 are often used in the literature together with biometrics. Finally, we give some
background about modeling and verification of real-time systems focusing on
how formal verification is used to verify the run-time monitor that we use in to
synchronize two ECG signals.

2.1. Body Area Networks

175 With the recent advances on technology, manufacturers are creating small
and affordable sensors that people can be equipped with in order to acquire
different parameters from their vital signs. For instance, athletes usually wear
chest band to measure the heart beats while training or even when they are
competing. In the case of elderly people, they might be remotely monitored
180 without the need to be in a medical center. Moreover, nowadays it is common
to have smartwatches or sport gadgets equipped with accelerometers, *Global
Positioning System (GPS)*, and PPG to measure the heart rate. These devices
also have communication modules such as WiFi, Bluetooth or RF.

When all these gadgets are working together, it is said that they are part
185 of a Wireless Body Area Network (WBAN) (Figure 2). That is, a WBAN is
a private network composed of sensors and/or actuators that measure different
vital signs and send this information to a central node, typically the bearer’s
smartphone—which is assumed to be trusted—that acts as a gateway between
the WBAN and the Internet [29, 30].

190 2.2. The Physionet Repository

Physionet [31] is a public repository composed of different databases about
physiologic signals of healthy and patients with diseases. The main purpose of
this repository is to allow and encourage researchers to investigate in the study
of diseases and physiologic signals. Specifically, in this work we are only focusing
195 on heart signals and, more precisely, in those databases with at least two ECG
channels. That being said, popular databases such as *fantasia* [32] or *apnea-ecg*
[33] are not considered in our study because there is only one ECG channel in
their records. On the contrary, when more than two ECG signals are found in

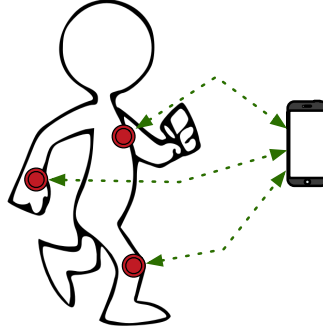

Figure 2: Body Area Network.

the same file, we are taking the first two signals we found (in a sequential order)
 200 in the *.hea* file which is a special file where the metadata of the record is stored.

In order to automate the process, we implemented a script to download 19
 databases from the Physionet repository. A description of the databases can be
 seen in Table 1 where the number of files represents the number of patients we
 used in our experiments. Apart from that, we computed the average number
 205 (median) of R-peaks (heartbeats) that both the first channel of the ECG (ECG_1)
 and the second channel of the ECG (ECG_2) have. For each database we also
 included the heart condition (if any) of the patients.

From that table it is interesting to see that the number of peaks, using the
 well-established Pan-Tompkins algorithm for peak detection [51], is only equal
 210 in three databases: *cebsdb*, *qtdb* and *vfdb* whereas the values are almost equal
 in the *iafdb* and *twadb* databases. All the rest of the databases (14 out of 19)
 have different number of peaks.

Finally, Figure 3 shows the number of patients that cannot be considered
 part of the dataset because they do not reach the minimum number of IPIs
 215 which is 8, 16 and 32 to compute the tokens of 32, 64 and 128 bits respectively.

2.3. Heart Signals in Cryptography

The use of ECG signals and IPI-based approaches for cryptographic appli-
 cations has been widely studied in the literature. Even though some researchers
 take more than the 4 *Least Significant Bits (LSBs)* of the IPI to generate cryp-
 220 tographic tokens, e.g., [52, 53]), the vast majority of the research community,
 e.g., [8, 10, 11, 13, 15, 20, 54, 17, 55, 56, 57, 18, 19] use the 4 LSBs extracted
 after applying the quantization algorithm explained in Section 3.2.1, or a slight
 variation of it proven to contain some degree of entropy. As we try to be as gen-
 eral as possible, we use the 4 LSBs to generate tokens in our experiments. It is
 225 worth mentioning that although our work is focused on IPI values, which is the

Database	Files	Peaks in ECG ₁	Peaks in ECG ₂	Heart condition
afdb [34]	23	49003	48294	Atrial fibrillation
afpdb [35]	300	1817	1797	Paroxysmal atrial fibrillation
ahadb [36]	2	8473	8183	Healthy and ventricular ectopy
cebsdb [37]	60	360	360	Healthy
edb [38]	90	8852	881	Myocardial and hypertension
iafdb [39]	32	91	88	Atrial fibrillation or flutter
incartdb [40]	75	2263	2327	Coronary artery disease
ltafdb [41]	84	110632	108205	Paroxysmal
mitdb [42]	48	2204	2227	Arrhythmia
nsrdb [43]	18	99746	10066	No significant arrhythmias
nstdb [44]	15	2556	2544	Mitdb with noise
precp [44]	10	4310	3355	Healthy
qtdb [45]	105	1044	1044	Holter recordings
sddb [46]	22	25969	36615	Arrhythmia
shareedb [47]	139	95809	95896	Hypertension
slpdb [48]	18	21087	23892	Sleep apnea syndrome
svdb [7]	70	2322	2323	Partial epilepsy
twadb [49]	100	185	184	Myocardial problems
vfdb [50]	22	3457	3457	Tachycardia

Table 1: Summary of the databases.

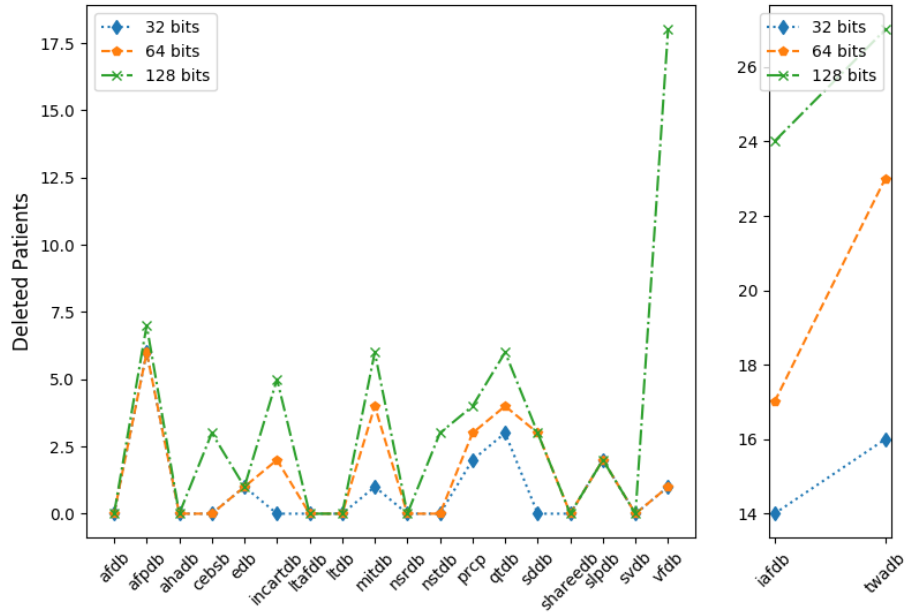

Figure 3: Deleted patients vs tokens length.

most widely used approach, some authors have proposed alternative solutions which work in a transform domain (e.g., [58] or [16]).

In most of the aforementioned IPI-based works it is assumed that there are two devices listening to the heart signal and they extract a random token which is used afterwards in a cryptographic protocol. However, to the best of our knowledge, no one has performed an in-depth empirical analysis to check if it is indeed possible to extract a common token from the same signal (particularly, the ECG) gathered from different devices over the same body. Our work aims to fill in this gap and focused exclusively on IPI-based approaches.

2.4. Fuzzy Extractor

Juels and Wattenberg were the first who introduced the term fuzzy commitment in [59], where a cryptographic key is extracted from a biometric signal such as an ECG or an *Electroencephalogram (EEG)*. The process of generating this key is through an algorithm called *fuzzy extractor*.

Fuzzy extractors are not only applied to key generation protocols based on biometrics [60, 61, 62] but also for generating keys for authentication purposes, by using *Physical Unclonable Functions (PUFs)* [63, 64], and for key generation in *Vehicular Ad-Hoc Networks (VANETs)* [65].

Formally, a fuzzy extractor is a function f which takes as input a biometric signal w , and produces a random string R and a public parameter P . Fuzzy extractors are particularly suitable for cryptographic protocols because when the input w' changes slightly, i.e., $w' = w + \epsilon$ for a very small ϵ , the random output R remains invariant [66].

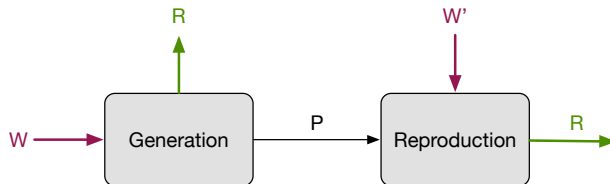

Figure 4: Scheme of fuzzy extractor [67].

Typically, a fuzzy extractor is composed of two main phases: *generation* and *reproduction* [66]. As it can be seen in Figure 4, in the generation phase, a biometric signal w is received as input and two parameters are given as output: a secret value R and a public value P . In the reproduction phase, a fresh biometric signal w' is given as input together with the public parameter P , previously generated in the generation phase. If and only if the distance between these two biometric signals—typically the Hamming distance—is less than a given threshold t_r ($\text{Hamming}(w, w') < t_r$), then the same output R will be retrieved.

2.5. Modelling and Verification of Real-Time Systems

Our application is a typical example of a real-time system, where a number of real-time constraints must be satisfied. Our proposed solution is based on

260 the satisfaction of three important real-time properties concerning: i) the time
between two consecutive peaks of each ECG signal; ii) the relative time between
peaks from the different heart signals; iii) the total sampling time to return back
a valid token. Note that this final requirement is to force the algorithm to finish
its execution after a fixed time. We give some upper-bounds of these times in
265 Section 3.3.2.

The design, reasoning and implementation of real-time systems have been
addressed by different communities, in particular by formal methods researchers
and more specifically those concerned with real-time verification [68]. In that
community, the idea is to make an abstract model to represent the real-time sys-
270 tem or some specific time constraints of the system, and apply tools to increase
the confidence that the model satisfies some properties. One of the most broadly
used formalism to model real-time systems is *timed automata* [69], for which reason-
able mature tools have been developed to reason about, e.g., UPPAAL [70]
and KRONOS [71]. In those tools, one specifies the model as a timed automata
275 and writes properties about it on a real-time logic called *Timed Computation
Tree Logic (TCTL)* [72].

The idea is that after performing such verification on the model, one may
then write an implementation by taking the timed automaton as a starting point.
Depending on the abstraction level of the model, the implementation might be
280 more or less difficult to obtain. Though there is a gap between the model and
the implementation, and errors might be introduced when an implementation
is obtained from the model, it is clearly an advantage to have a verified model
in the first place. As we will see later, in our case the implementation is di-
rectly obtained from the model, which gives us quite a high confidence on the
285 correctness of our solution with respect to the specified timing constraints.

3. ECG-Based Token Generation Procedure

In this section, we first explain the methodology we have followed to carry out
our research. We then explain in detail how we generated tokens from different
ECG signals, and demonstrate how a pre-processing phase is needed to agree
290 on the same token generated. Finally, we propose a timed automaton satisfying
our properties and create the corresponding monitor in order to synchronize the
signals (and thus generate the same token).

3.1. Our Methodology

All the experiments presented in this section were run on a Macbook Pro
295 2.4Ghz with 4Gb of RAM. The processing of all the patients' signals were im-
plemented on Matlab.

We analyze all the performed experiments and discuss the results obtained
after generating two tokens independently (emulating different sensors) in 4
scenarios: 1. running a quantization algorithm (Section 3.2.1); 2. running a
300 fuzzy extractor algorithm (Section 3.2.2); 3. running a run-time monitor (Section
3.3.1), and; 4. running a run-time monitor and a fuzzy extractor algorithm

(Section 3.3.2). Finally, from our results we conclude that synchronization of the signals is a must if we want the sensors to derive the same token from the ECG signal.

305 Regarding the run-time monitor, two specific values need to be computed beforehand: the time between two consecutive peaks from both the same ECG channel and from different channels. To generate an upper-bound of those values with statistical significance, we require the person to be quite and calm. However, due to the fact that we are using the Physionet repository with all
310 the signals already measured, we decided to use the mean of the time interval between R-peaks of each one of the signals as an upper-bound which is a common technique used in medical research [73]. Additionally, we set the maximum time between consecutive peaks for different signals in the case of Physionet repository to $\frac{1}{f_s}$ where f_s is the reading frequency of the device where the signal
315 is gathered. This is due to the fact that this parameter is determined by the physical distance between sensors and in the case of the Physionet databases, all the patients were monitored using wired ECG sensors attached to their chest.

Having computed those numbers, we have verified three main properties: i) the time between two consecutive peaks of each ECG signal; ii) the relative
320 time between peaks from the different heart signals, and; iii) the total sampling time. Similarly [20], we consider that when the time interval between two consecutive peaks from the same signal is longer than the computed upper-bound, then the monitor resets its clocks and considers that there a miss-detected peak was found. Also, when the time interval between two consecutive peaks from
325 different signals is longer than $\frac{1}{f_s}$ then the monitor resets its clocks and considers that those peaks are not synchronized. Finally, we have proved that after t seconds, the final state is always reached and if and only if there are enough synchronized IPI then a token is computed.

3.2. Debunking ECG-Based Token Generation Myths

3.2.1. Token Generation Algorithm

330 Our first experiment goal was to generate as many tokens of 128 bits as possible from both channels (ECG_1 and ECG_2) of the patients of all the databases to know how different they are. In order to process the ECG signal—which is a continuous signal, it must be transformed to a discrete one. This process is
335 known as *quantization* (e.g., uniform or dynamic quantization) and it is one of the most important steps in the token generation based on heart signals [74].

As far as we know, in the context of ECG IPI-based approaches, the dynamic quantization firstly proposed by Rostami *et al.* in [8] is the most extended in the literature. In a nutshell, their algorithm works as follows. First, the ECG signal
340 is cleaned (i.e., the DC component is eliminated and then the ECG signal is passed through a pass-band filter with 0.67Hz and 45Hz cut-off frequencies [75]). Second, R-peaks are extracted from the heart signal by using Pan-Tompkins algorithm [76] and the time difference between R-peaks are computed and thus, the IPIs are generated. Third, the IPIs values are dynamically transformed
345 into values between 0 and 1. Then the data are multiplied by 256 and rounded

to the nearest integer. Finally, the Gray code encoding scheme with 8-bit of precision is used to facilitate error correction and the 4 LSBs of each IPIs are extracted to generate a token. This token is computed by appending these 4 LSBs [17, 19]; in order to create a 128-bit number at least 32 IPIs should be processed. The source code of the dynamic quantization is freely available at <https://github.com/aylara/synchro> (i.e., see `getIPIsSignal.m` file).

The pseudocode of the aforementioned IPI extraction algorithm, which is also used in this paper to process the signal and extract the 4 LSBs of the IPIs, is shown as Algorithm 1.

Algorithm 1 IPIs' extraction.

```

1: procedure IPIGENERATION(record)
2:   signal  $\leftarrow$  get_signal(record)
3:   freq  $\leftarrow$  get_sampling_frequency(record)
4:   cleaned_signal  $\leftarrow$  ECG_pre-processing(record)
5:   IPIs  $\leftarrow$  Pan_Tompkins(cleaned_signal,freq)
6:   IPIs  $\leftarrow$  dynamic_quantization(IPIs)
7:   result  $\leftarrow$  []
8:   for ipi  $\in$  IPIs do
9:     grey $\leftarrow$  grey_code(ipi)
10:    IPINEW  $\leftarrow$  get_LSB(gray)
11:    result.append(IPINEW)
12:  end for
13:  return result
14: end procedure

```

As mentioned before, we generate as many 128 bits tokens as possible per user per database and the result of this analysis can be seen in the second column of Table 2. Note that this column contains the sum of all the tokens extracted per database for only one channel (ECG₁ or ECG₂). Also, we computed how many of these tokens are similar by calculating the Hamming distance between each pair of tokens from both channels (ECG₁ and ECG₂) before performing any signal processing and compared them pairwise. The results can be seen in the third column of Table 2. It is interesting to see that the number of similar tokens is extremely low in all databases which means that the output of the quantization algorithm cannot directly be used to generate similar tokens in different devices.

As a conclusion, we corroborate our claim that just applying an IPI extraction algorithm like the one presented in Algorithm 1) composed of the Pan-Tompkins algorithm plus a dynamic quantization to generate tokens is not enough to guarantee that the same token will be generated in two different sensors.

DB	Tokens (Alg 1)	Similar tokens	Similar tokens (FE)	Tokens (RM)	Similar tokens (RM)	Similar tokens (RM+FE)
afdb	35690	8 (0.02%)	77 (0.2%)	1549 (%)	847 (54.6%)	1495 (96.5%)
afpdb	14505	40 (0.27%)	740 (5.1%)	9251 (%)	45 (0.48%)	1196 (12.9%)
ahadb	511	0 (0%)	0 (0%)	15 (%)	2 (13.3%)	14 (93.3%)
cebsdb	2577	2 (0.07%)	1360 (52.7%)	839 (%)	59 (7.0%)	835 (99.5%)
edb	24262	21 (0.08%)	497 (2.0%)	3769 (%)	1995 (52.9%)	3706 (98.3%)
iafdb	207	0 (0%)	34 (16.4%)	23 (%)	11 (47.8%)	23 (100%)
incartdb	5127	0 (0%)	69 (1.3%)	1117 (%)	4 (0.3%)	241 (21.5%)
ltafdb	271605	185 (0.06%)	1188 (0.4%)	21337(%)	92 (0.4%)	870 (4.0%)
mitdb	3198	0 (0%)	45 (1.4%)	770 (%)	0 (0%)	110 (14.2%)
nsrdb	52290	1980 (3.7%)	4072 (7.7%)	13965(%)	26 (0.1%)	1176 (8.4%)
nstdb	1160	0 (0%)	8 (0.6%)	171 (%)	0 (0%)	25 (14.6%)
prcp	825	0 (0%)	0 (0%)	22 (%)	2 (9.0%)	20 (90.9%)
qtdb	3413	1 (%)	216 (6.3%)	1346 (%)	695 (51.6%)	1315 (97.6%)
sddb	21280	1212 (5.6%)	1732 (8.1%)	1364 (%)	572 (41.9%)	1029 (75.4%)
shareedb	405775	2638 (0.6%)	4758 (1.1%)	60440(%)	297 (0.4%)	3229 (5.3%)
slpdb	8860	0 (0%)	0 (0%)	172 (%)	27 (15.6%)	169 (98.2%)
svdb	5710	2 (0.03%)	105 (1.8%)	2984 (%)	9 (0.3%)	315 (10.5%)
twadb	528	0 (0%)	31 (5.8%)	204 (%)	107(52.4%)	203 (99.5%)
vfdb	2144	0 (0%)	49 (2.2%)	221 (%)	93 (42.0%)	216 (97.7%)

Table 2: Number of tokens of 128-bit tokens generated by Algorithm 1 (column 2); Number of similar tokens after running Algorithm 1 (column 3); Number of similar tokens after running Algorithm 1 + Fuzzy Extractor (FE) (column 4); Number of tokens after running Algorithm 1 + Run-time Monitor (RM) (column 5); Number of similar tokens after running Algorithm 1 + Run-time Monitor (RM) (column 6); Number of similar tokens after running Algorithm 1 + Run-time Monitor + Fuzzy Extractor (RM+FE) (column 7).

3.2.2. Fuzzy Extractor

Following the scheme presented in [61], we implemented a fuzzy extractor algorithm, which was specifically adapted to work with ECG signals. The scheme of the fuzzy extractor can be seen in Figure 5. The fuzzy extractor takes as
375 input two ECG signals (ECG_1 and ECG_2) and two random numbers ($PRNG_1$ and $PRNG_2$). The ECG_1 and the mentioned random numbers are provided in the generation phase since they are needed in the computation of the *Helper Data* (i.e., (s, x)), which is used in the reproduction phase together the ECG_2 signal. The result of the fuzzy extractor is a pair of identical values R . Our
380 fuzzy extractor is publicly available at <https://github.com/aylara/synchro> (i.e., see `simulation_fuzzyextractor.m` file).

We assign the following values for the parameters m , n , k and t of the BCH: $m = 7$, $n = 127$, $k = 50$, $t = 13$, following the guidelines given in [61]. The
385 parameter $t = 13$ represents a trade-off between the correction capability and the the ability the adversary has to break the protocol. Thus this parameter should not be increased arbitrarily since it would increase the success probability of an adversary. This means that the BCH can recover at most 13 different bits from words of 128 bits (i.e., a 10% of the bits). We urge the reader to consult [77] for a detailed description of BCH parameters and their implications. An
390 additional argument for this 10% value ($t = 13$) is that we have empirically demonstrated that is not possible to achieve 90% of similarity in the tokens

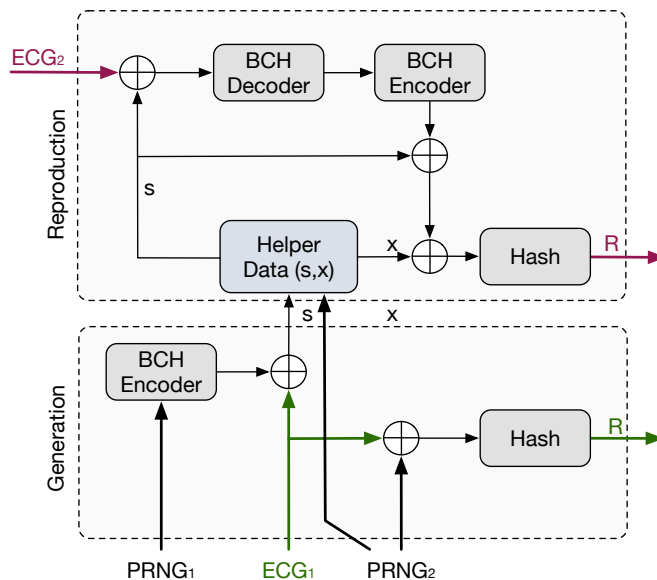

Figure 5: Fuzzy extractor.

generated without our run-time monitor together with the fuzzy extractor (see columns 3 and 4 from Table 2).

In order to check how the fuzzy extractor behaves, we used the output of the Algorithm 1 as input of the fuzzy extractor and computed the Hamming distance between each pair of tokens compared tokens pairwise and the results can be seen in the third column of Table 2. Even if our fuzzy extractor produces a slight improvement, with respect to the results obtained without performing any pre-processing of the signal (see column 2), the results are far from being the expected ones. For instance, the *cebsdb* database which achieves a 52.7% of the similar tokens in both channels is not a good result, i.e., 1 out of 2 generated tokens is random. The reason for getting these poor results stems from the fact that the distance between the IPIs calculated from each sensor clearly exceeds the correction capacity of the fuzzy extractor (BCH encoder). In our experimentation, for words of 128 bits the correction capacity is set to $t = 13$.

3.3. How to Generate ECG-Based Tokens

3.3.1. Timed Automata

Timed automata are composed of five main parts: clocks, time-checks, actions, events and states. For our timed automaton, we have defined three different clocks, namely c_1 , c_2 and c_3 , which are in charge of checking the time properties of the heart beats in our model. Concretely, c_1 checks an upper bound for the execution of the automaton, that is, how long the automaton should be

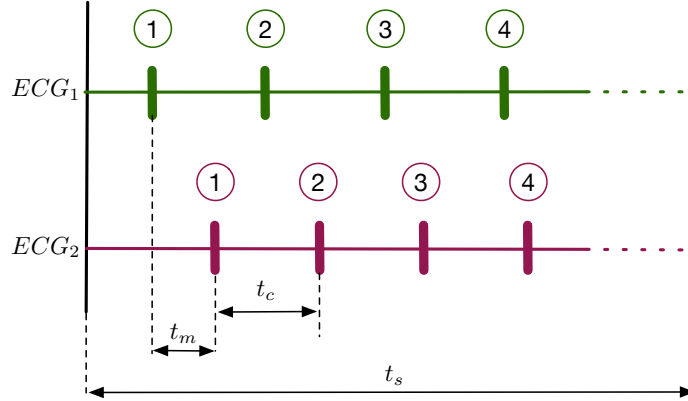

Figure 6: Time-checks used in the timed automaton.

executed; c_2 checks when the peaks from both signals are synchronized or not,
 415 and; c_3 checks when there are missed peaks in the same signal.

All the time checks used in the automaton were obtained after having analyzed all databases. We show in Figure 6 a representation of these time checks. More concretely:

420 t_c This value varies in time and between each person. In order to compute t_c , as stated in Section 3.1, the person should be in a quite and peaceful environment. For our experiments and following the similar technique proposed in [73], we calculated the mean time between R-peaks of each pair of ECGs (ECG_1 and ECG_2), which is the value assigned to the time-check t_c .

425 t_m This value is determined by the physical distance between sensors and hence, it is directly affected by the speed of the blood pumped from the heart to the rest of the body. In our particular case, all the databases of the Physionet repository always consider electrodes attached to the chest of the patients, so we forced this value to be less than $\frac{1}{f_s}$ where f_s is
 430 the sampling rate. So, $t_m < t_c$, otherwise a missed peak is detected and discarded by the automaton.

435 t_s This value is a bound that determines how long each “session” of the execution of the monitor should be. We set this value to be equal to the longest signal encountered in our databases, in order to ensure we consider all the signals.

Table 3 shows all the variables and constants of our automaton (shown in Figure 7), defined as a tuple $\mathcal{A} = \{L, X, \Sigma, \Delta, F\}$, where:

- $L = \{E_0, E_1, E_2, E_3, E_4\}$ is the set of locations (with E_0 and E_4 the initial and final states, respectively);

Clocks	
c_1	Sampling time
c_2	Time between peaks of two signals
c_3	Time between two consecutive peaks (same signal)
Time-checks	
t_c	Time between two consecutive peaks (same signal)
t_m	Time between peaks of two signals
t_s	Sampling time
Actions	
<i>Log</i>	Stores those IPIs which are not synchronized
<i>Reset</i>	Initializes the clocks given as input
<i>ReturnPeaks</i>	Returns the non-synchronized IPI set
<i>Sync</i>	Checks what IPIs are synchronized
Events	
$Peak_{ECG_x}$	R-Peak of ECG_x , where $x \in [1, 2]$
ϵ	No event
States	
E_0	Initial state
E_1	When a peak of the first signal is detected
E_2	When a peak of the second signal is detected
E_3	When one peak of each signal is detected
E_4	When the max time is detected ($c_1 \geq t_s$)

Table 3: Properties of the automaton (Figure 7).

- 440
- $\Sigma = \{Log, Reset, ReturnPeaks, Sync\}$ are all the actions;
 - $X = \{c_1, c_2, c_3\}$ is the set of clocks;
 - $\Delta \subseteq L \times X \times \Sigma \times 2^X \times L$ is the transition relation, where $F \subseteq L$ is a set of accepting locations.

The Log action keeps a list of those IPIs which are not synchronized according to our time constraints. Reset initializes the clocks given as input. 445 *ReturnPeaks* returns the list of non-synchronized IPIs. Finally, the Sync action computes the list of IPIs which are synchronized.

Regarding the *events*, we have two types: when a peak comes from the ECG_1 or from the ECG_2 . Additionally, we have defined ϵ which means that we do not 450 wait for any event to occur and we force the runtime monitor to check if the condition is satisfied to perform the transition to the corresponding state.

The automaton has 5 *states*. All the clocks and variables are set to 0 in the initial state E_0 . Note that whenever $c_1 \geq t_s$ then the computation finishes (the automaton is in state E_4). The rest are intermediate states, ensuring progress 455 in the computation provided the relevant timing constraints are respected (“accepting” or “rejecting” peaks).

We implemented our timed automaton in Uppaal [70], allowing us to validate and verify our model in a formal way. Our verified model was then translated

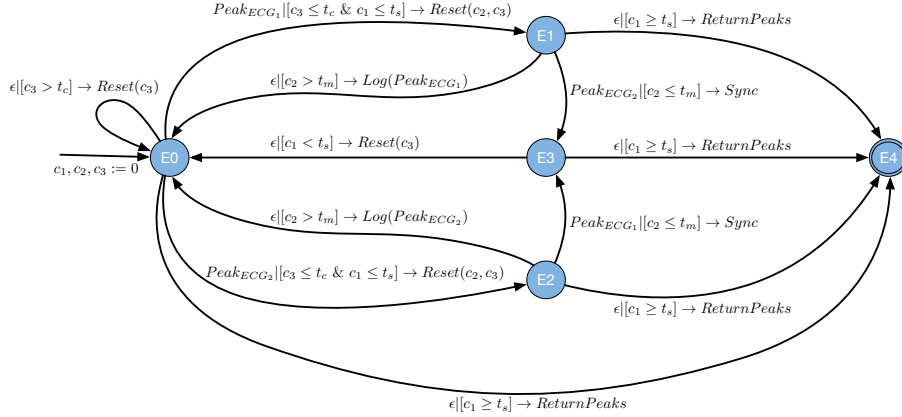

Figure 7: Heart based timed automaton.

into a *runtime monitor* implemented as Matlab code. The source code of both
460 implementations are available at <https://github.com/aylara/synchro> (i.e., see Automaton and UPAAL folders).

We tested our generated runtime monitor with the output of the Algorithm
1. The number of tokens has decreased considerably as it can be seen in the
fifth column of Table 2. After that, we then computed the Hamming distance
465 between each pair of tokens compared pairwise and the results can be seen in the
sixth column of Table 2. Note that, in general, the number of similar tokens has
increased considerably after running the run-time monitor with respect to the
third column. However, this improvement does not come for free. The penalty
we have to pay is that the number of tokens has decreased per database as it
470 can be seen in fifth column of such a Table.

3.3.2. Timed Automaton & Fuzzy Extractor

As already explained, our approach consists of combining our monitor (ex-
tracted from our verified timed automaton, for synchronizing the tokens (based
on IPI values) extracted from two different ECG signals) and the fuzzy extractor
475 (to correct some bits).

The results can be seen in the last column of Table 2. After applying this
solution we can successfully generate the same token from different sensors with
high probability in the majority of the databases, i.e., 10 out of 19 databases
have a probability higher than 90% of taking two similar tokens generated on
480 different sensors. However, despite of our method improves the current state of
the art, it will remains low for 8 databases, namely *afpdb*, *incartdb*, *ltafdb*, *mitdb*,
nsrdb, *nstdb*, *sharedb* and *sddb* whereas *sddb* achieves a 75.4% of probability
that two arbitrary tokens be similar.

From the above results, we can clearly conclude that the best databases
485 to be used to extract cryptographic tokens are the ones with healthy patients.
Moreover, our method seems to work reasonably well with those patients whose

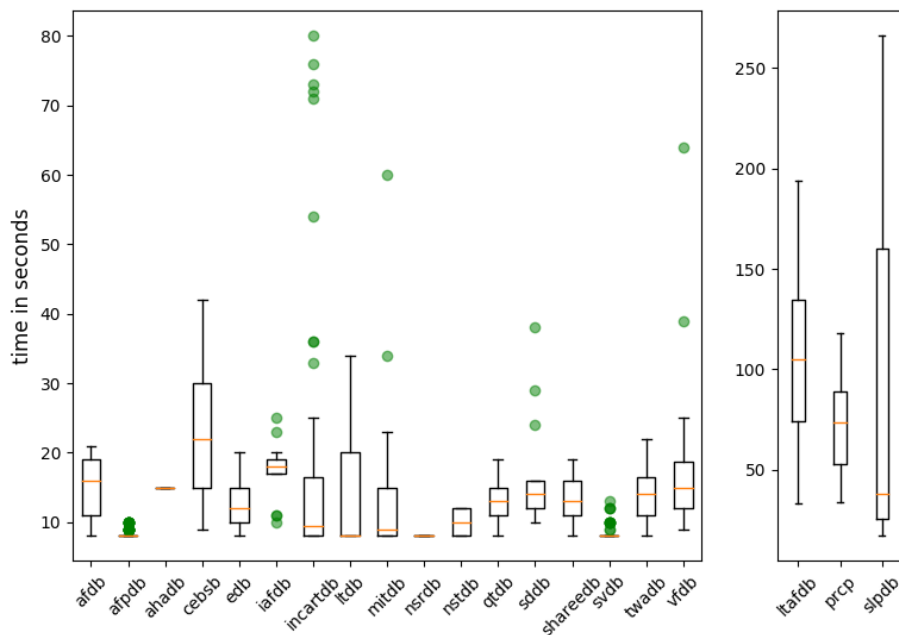

Figure 8: Time needed to generate a 32-bit token.

disease is not severe. Hence, we recommend not to use databases such as *mitfdb* which is widely used in the research community for security purposes [8, 20, 53, 78, 79] or *nsrddb* [19, 80] to mention a few.

490 Having empirically demonstrated the effectiveness of our proposed method, the only question that remains uncovered yet is how long the run-time monitor needs to listen to the heart signal in order to obtain a token which can be used later on as part of a cryptographic protocol.

495 We conducted an additional experiment to measure how long the run-time monitor needs to keep listening an ECG signal in order to produce a token of 1. 32 bits (Figure 8); 2. 64 bits (Figure 9), and; 3. 128 bits (Figure 10). To carry out this test, we modified the original timed automaton (Figure 7) in such a way that, instead of having 3 different clocks (c_1 , c_2 and c_3), we only keep c_2 and c_3 , and replace c_1 by a counter. By doing so, as soon as the automaton
500 detects that the length of the token is 32, 64 or 128 respectively, then the final state E_4 is reached. Roughly speaking, taking into account that we can only extract the 4 LSBs from an IPI, the automaton will stop when it finds 8, 16 or 32 synchronized IPIs. We have then re-implemented our new automaton in Matlab, getting a new monitor.

505 Furthermore, in order to make Figures 8, 9 and 10 more readable, we decided to discard some of the outliers and we kept the 70% of the original data. It can be observed that, in order to get a 32-bit token, sensors need to listen approximately for 13 seconds on median. Similarly, to get a 64-bit or 128-bit

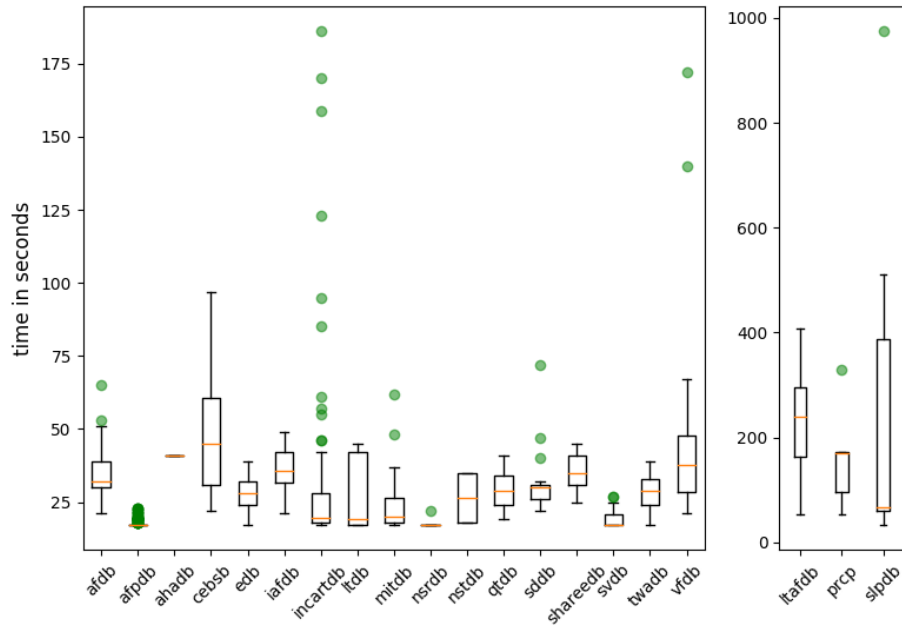

Figure 9: Time needed to generate a 64-bit token.

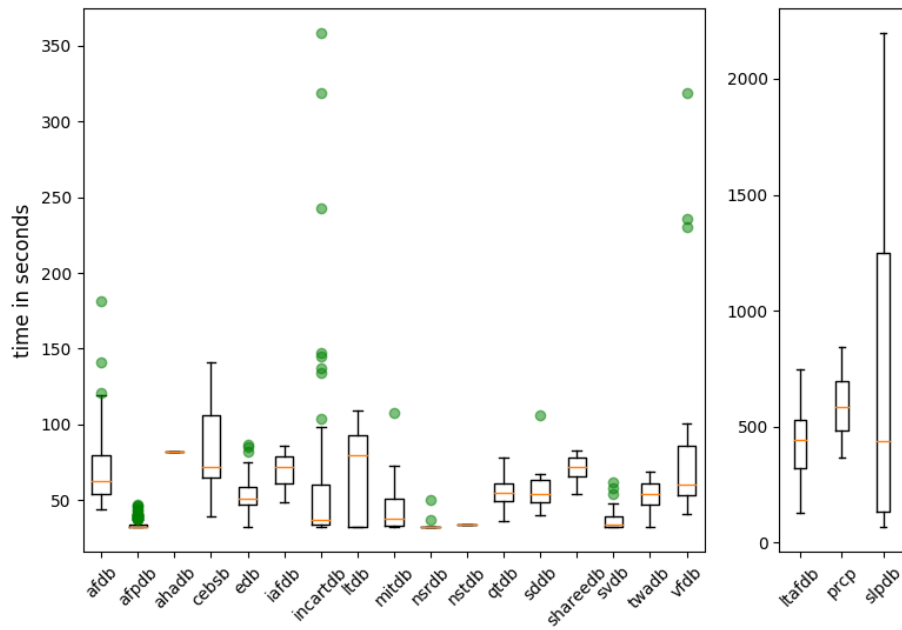

Figure 10: Time needed to generate a 128-bit token.

token, they should listen the ECG for 28 and 56.5 seconds, respectively, on
510 median. It is also noticeable that although at a first sight the above mentioned
timing values might appear to be excessive, this generation process will only be
executed once, typically in the setup phase of the cryptographic protocol (e.g.,
key generation and synchronization processes between two sensors).

4. Proposed Solution

515 In this Section we provide a proof-of-concept implementation to demonstrate
whether two sensors can derive the same token from the heart signal using
real hardware. The purpose of the presented proof-of-concept is to show the
feasibility of our solution as well as the minimum requirements for generating
common tokens on different ECG sensors. For this first approach, and similarly
520 to previous proposals (e.g., [23, 81, 82]), we assume the communications to be
secure between the sensors and the gateway (at least during the set-up phase).
Alternatively, we could have used noisy cryptography [83] to share sensitive
information (the two ECGs in our particular case) via insecure channels.

A real example in which the above scenario can occur is as follows. Imagine
525 that Alice is wearing a smart T-shirt with an ECG monitor similar to the one
proposed in [84]. This T-shirt is already paired with her smartphone which
makes the communication channel secure. Additionally, she has a pacemaker
which is as well paired with the smartphone. In this scenario, the smartphone
is acting as a WBAN gateway due to its computational resources in terms of
530 CPU, storage, memory and communication capabilities. The above example is
integrated within what is called body area networks. Another example, perhaps
more futurist and within the area of the intelligent and connected cars could
be the following. A driver (Bob) holds a smart-watch with an ECG sensor—
note that this type of product is already on the market [85]. As for the car,
535 the steering wheel, and as a novelty, also has an ECG sensor [86, 87]. As
in the above example, both ECG sensors are securely connected to the car’s
central control system that acts as gateway. The two described examples are
completely different but in both scenarios the two sensors must calculate the
same cryptographic token (derived from the ECG recorded by each sensor) with
540 the help of the gateway.

Summarizing, our system has three entities: a gateway and two ECG sensors
(e.g., smart T-shirt and pacemaker).⁴ Figure 11 provides an architectural
view of the system. Once the ECGs signals have been gathered by the sensors,
they are sent to the gateway in order to be synchronized by using the
545 timed-automation (see Section 3.3.1 and Figure 7). After that, the already syn-
chronized signals are sent back to the sensors, the peak extractor procedure
(Algorithm 1) is executed to extract the tokens, and finally the fuzzy extractor
(see Section 3.2.2 and Figure 5) is applied to the processed signals in order to
generate the same cryptographic token.

⁴Note that it could have also been possible to use one of the sensors as a gateway.

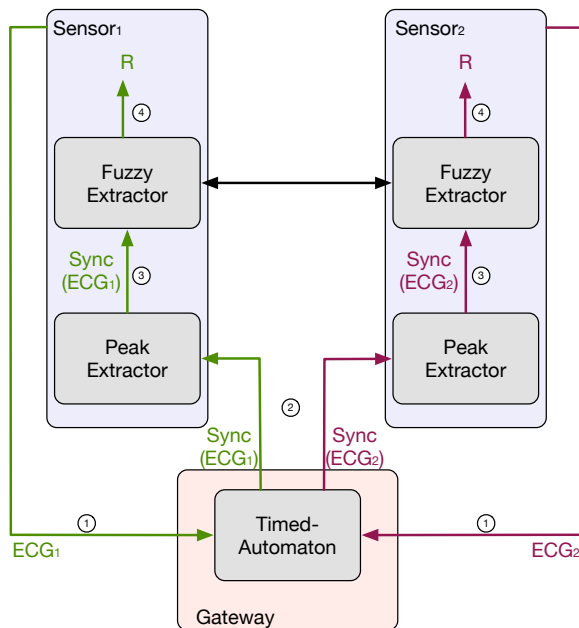

Figure 11: System model using both a timed automaton and a fuzzy extractor.

550 We have basically deployed the scheme presented in Figure 11 by using a low-cost hardware dedicated for research purposes named BITalino⁵. This shield has two ECG channels and a Bluetooth connection. As in the Alice example, we had to pair our hardware with the gateway which, in our case, was a laptop as can be seen in Figure 12.

555 More concretely, it works as follows: 1) First, sensors measure the heart signal and send the gathered ECGs to the gateway via a secure communication channel. Once the signal is received by the gateway, the run-time monitor is executed in order to synchronize both signals. 2) After the signals are synchronized, the sensors receive the position of the peaks that must be removed by the gateway. For this communication to occur a secure channel is also needed. 560 3) When the the list of peaks to be removed is received, the sensors proceed to delete them—note that at this point both signals are synchronized in terms of R-peaks—in order to proceed with the token generation. 4) Finally, a fuzzy extractor is applied to the processed signal in order to generate the same token. 565 The helper data can be transmitted from one sensor (generation process) to the other one (reproduction process) without the necessity of a secure channel.

It is worth mentioning that the gateway cannot generate a token by itself to be used in the WBAN; its role is to synchronize the signal and thus helping

⁵<http://bitalino.com/en/>

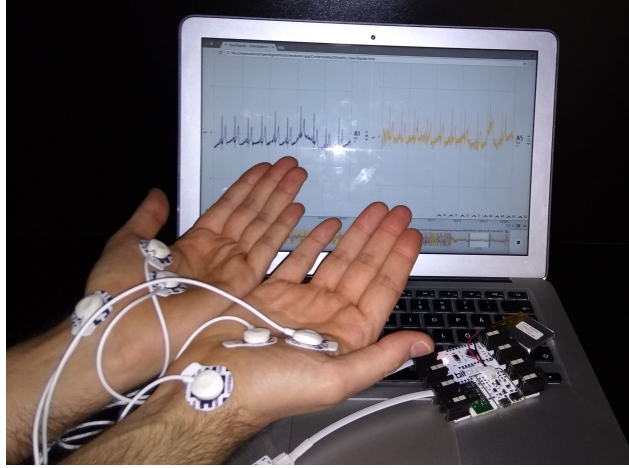

Figure 12: Proof-of-concept based on the BITalino platform.

the sensors to generate a shared token. However, at the end of this protocol,
570 not only the sensors can generate the same token but also the gateway may
do it. The source code of our implementation can be downloaded from <https://github.com/aylara/synchro>.

4.1. Security Analysis

In order to solve the problem of creating the same token in two sensors, two
575 aspects need to be addressed: i) a secure communication channel (sensor(s)–
gateway) must be used, and; ii) sensors have to share their gathered ECGs with
the gateway to synchronize them.

Traditionally, authors have assumed that different sensors can extract the
same token by measuring the same signal from an organ (in our case the heart).
580 Most authors rely on the fact that, in order to derive the same token, the (active)
attacker must be reading the ECG of the bearer at the same time as the devices
are and such probability is almost negligible [88]. On the other hand, other
proposals (e.g., [8, 20]) assumed that the communication can only be established
if the devices are close enough (commonly named as neighborhood area): the
585 attacker should be a few centimeters from them and would be easily detected.
In these security protocols, the ECG is used to derive a common secret between
different sensors and thus, the ECG can be considered as the secret key. The
signal must therefore be transmitted over a secure communication channel.

A more recent approach was presented in [81]. In this work, authors use the
590 ECG to securely distribute symmetric cryptographic keys. However, authors
use a trusted central node in charge of establishing a secure communication
between sensors that want to share some data. In this approach all the devices
(two sensors and the gateway) are on the body as they need to record the ECG
at the same time and by themselves—in our case only the two sensors have

595 to collect the ECG signal—and the secure channel is established by using a
fuzzy commitment scheme [59]. In this work, we demonstrated that only by
using a fuzzy commitment scheme is not enough to generate the same token
in different devices. In [81] and our proposal, once the cryptographic token
synchronized between the sensors is established, they can exchange information
600 directly without involving anyone else. For instance, after the setup phase,
smart-watches, wrist-bands and IMD can securely exchange data with each
other regardless of the brand, manufacturer or the purpose of the device.

It is important to note that our proof-of-concept implementation is secure
if and only if the communication channel between the sensors and the gateway
605 is secure (like most of the proposed solutions in this field). This is because
both sensors are sending the ECG to the gateway and thus, an attacker (\mathcal{A}) can
sniff the communication channel, extract the signals and perform the matching
operation. The only extra information that \mathcal{A} would need is the specific instant
the tokens have started to be computed. It is also remarkable that the secure
610 channel requirement is only used for the very first time (set-up phase of the
protocol); once the two ECG signals are synchronized, there is no longer any
need to keep the channel secure.

In this paper we empirically demonstrated that the assumption of two sensors
deriving the same token from the heart (ECG signal), is at least questionable.
615 We showed that, in addition to the error correction techniques, a new step
is needed before extracting such a token: the synchronization of the signal.
To achieve this, there are two options: 1) one of the sensors sends the ECG
to the other one in order to synchronize the signal and the latter sends the
synchronized signal back to the first one, or; 2) a trusted and external party
620 is used to synchronize the signal and communicate the final decision to the
sensors. Either way, the main consequence from a security point of view is
that now Eve—a passive attacker, just by eavesdropping on the communication
channel might synchronize both ECG signals and extract a common key. To
combat this we proposed two main approaches: 1) assume a secure channel in
625 the set-up phase, or; 2) assume that the channel is insecure all the time and
use some protection mechanism such as solutions based on noisy cryptography
[83].

5. Related work

Several studies have been done in the area of security and privacy applied
630 to biometrics, and in particular where heart signals are involved (e.g., [8, 9, 19])
In most of these works, there are three main assumptions: 1) bits extracted
from the heart signal can be considered random [8, 10]; 2) two sensors placed
in the same body can generate the same random token from the heart signal
[11, 20, 18, 78], and; 3) two sensors should gather 32 consecutive peaks in
635 order to generate a 128 bits nonce which is approximately a 32 seconds signal
[13, 19]. As far as we are concerned, this work is the first one that empirically
demonstrates that the usual assumptions made in the aforementioned papers

regarding the token generation in different devices at the same time are at least questionable.

640 On the one hand, it is usually assumed that the random numbers derived from IPIs can be directly used on cryptographic applications because of the high entropy degree that the 4 LSBs have. Additionally, some researchers have tried to improve the strength of the entropy per IPI in order to guarantee a higher security level [10, 15, 18]. However, Ortiz *et al.* questioned the entropy quality
645 of the IPI values and the dependence of the results on the dataset used [26]. In our work, the involvement of the two sensors is necessary because thanks to this (and the acquisition of the same IPI values derived from the recorded ECGs) they mutually verify they are close to each other (i.e., that they are in the neighbourhood area as is commonly named in distance bounding protocols) and
650 additionally they can authenticate each other. Therefore, this kind of distance checking (and mutual authentication if necessary) is made by the participation of both sensors (on the same organ).

On the other hand, researchers have usually assumed that a person equipped with different heart sensors can extract the same nonce from the ECG by using
655 a fuzzy extractor (see [80] for a comparison between fuzzy commitment and fuzzy vault schemes). For example, authors in [8] propose a security protocol where a patient equipped with an IMD and a doctor with a Programmer can extract the same nonce from the patient's ECG. Similar assumptions are made in [9, 78, 27], just to cite a few of them. Contrarily to any prior proposals, in
660 our work we have demonstrated that error correction algorithms, such as fuzzy extractors, are not enough to claim that sensors placed in different parts of the body can generate the same token using an IPI-based approach.

Recently, some authors have taken into account that some events may occur during the measurement process that increase the difference between the gen-
665 erated tokens. For instance, it is possible that noise appear in the extraction of the signal and the detection of heart peaks will be affected [20]. Because of that, [20] proposes a mechanism to statistically calculate where a peak should be in the ECG signal and they manually add it so that the entropy degree is not affected. Also, other parameters such as HRV and VAR_{is} can alter the peak
670 detection algorithm [21] and they must be taken into account to ensure that the keys are equal enough. In this work, we not only take those issues into consideration but also the heart signal is never modified so that other computations can be applied over the signal such as medical checks of the heart.

Finally, it was stated in [8, 11, 27, 28], that sensors have to keep listening
675 the ECG for about 30 seconds to generate a 128 bits token. In our work we have proved that in order to generate a 128 bits token, two sensors should be reading the heart signal for almost 1 minute (56.6 seconds) on median, time which we have obtained experimentally and it is in general much larger that it was previously claimed.

680 6. Conclusion

In this paper we tested whether error corrections algorithms, including fuzzy extractors, can be used alone to claim that two different sensors are able to derive equal tokens from two ECG signals measured at different parts of the body by using an IPI-based approach as proposed in many previous works [8, 10, 11, 685 15, 27]. We run the experiments against 19 public databases from Physionet repository, and we can clearly conclude that a pre-processing of the heart signal is mandatory for generating the same token. Because of that, we proposed a run-time monitor, based on a timed automaton, to synchronize both ECG signals before the peaks are computed and before the fuzzy extractor takes 690 place. Finally, we run once again the same experiments and errors are reduced to zero in many of the tested databases.

Additionally, we also conducted one more experiment to check how long the sensors should record the heart signal in order to generate tokens of 32, 64 and 128 bits and, contrarily to what it is usually assumed (6, 12, and 24 seconds 695 for individual with a heart rate of 80 bpm), the sensors have to wait 13, 28 and 56.5 seconds on median respectively to derive the same token from two ECG sensors.

Future Work. There have been two main decisions we made which might be improved in the future.

700 Timed Automaton. The mean value has been used as the upper-bound time for RR intervals as it has been previously proposed in medical research [73], and the consequence is that certain peaks are missed and the run-time monitor does not synchronize as many peaks as it might do. We plan to further research on this line and refine our timed automaton to achieve 705 better results, specially in those databases that do not perform as well.

Extend to other biometrical signals. We have focused on heart signals by using two channels (ECG_1 and ECG_2). We plan to extend our analysis and proposal to other physiological signals like Photoplethysmograms (PPGs), Blood Pressure (BP) or even using the Electroencephalograms (EEGs), as 710 proposed in [89].

7. References

References

- 715 [1] H. Hamidi, An approach to develop the smart health using internet of things and authentication based on biometric technology, *Future Generation Computer Systems* 91 (2019) 434 – 449.
- [2] S. Kumar, S. K. Singh, Monitoring of pet animal in smart cities using animal biometrics, *Future Generation Computer Systems* 83 (2018) 553 – 563.

- 720 [3] J. Wayman, A. Jain, D. Maltoni, D. Maio, An Introduction to Biometric Authentication Systems, 2005, pp. 1–20.
- [4] A. M. Intelligence, The Global Biometrics and Mobility Report: The Convergence of Commerce and Privacy , Tech. rep., Acuity Market Intelligence (06 2015).
URL <http://www.acuity-mi.com/GBMRIntroPreview.pdf>
- 725 [5] A. Eng, L. A. Wahsheh, Look into my eyes: A survey of biometric security., in: S. Latifi (Ed.), ITNG, 2013, pp. 422–427.
- [6] T. Denning, A. Borning, B. Friedman, B. T. Gill, T. Kohno, W. H. Maisel, Patients, pacemakers, and implantable defibrillators: Human values and security for wireless implantable medical devices, in: Conference on Human
730 Factors in Computing Systems, 2010, pp. 917–926.
- [7] S. D. Greenwald, R. S. Patil, R. G. Mark, Improved detection and classification of arrhythmias in noise-corrupted electrocardiograms using contextual information, in: [1990] Proceedings Computers in Cardiology, 1990, pp. 461–464.
- 735 [8] M. Rostami, A. Juels, F. Koushanfar, Heart-to-heart (h2h): authentication for implanted medical devices, in: CCS '13, 2013, pp. 1099–1112.
- [9] C. C. Y. Poon, Y.-T. Zhang, S.-D. Bao, A novel biometrics method to secure wireless body area sensor networks for telemedicine and m-health, IEEE Communications Magazine 44 (4) (2006) 73–81.
- 740 [10] R. M. Seepers, C. Strydis, I. Sourdis, C. I. D. Zeeuw, Enhancing heart-beat-based security for mhealth applications, IEEE Journal of Biomedical and Health Informatics 21 (1) (2017) 254–262.
- [11] S. D. Bao, C. C. Y. Poon, Y. T. Zhang, L. F. Shen, Using the timing information of heartbeats as an entity identifier to secure body sensor network, IEEE Transactions on Information Technology in Biomedicine 12 (6)
745 (2008) 772–779.
- [12] C. Camara, P. Peris-Lopez, J. E. Tapiador, Human identification using compressed ecg signals, Journal of Medical Systems 39 (11) (2015) 148.
- 750 [13] G. H. Zhang, C. C. Y. Poon, Y. T. Zhang, Analysis of using interpulse intervals to generate 128-bit biometric random binary sequences for securing wireless body sensor networks, IEEE Transactions on Information Technology in Biomedicine 16 (1) (2012) 176–182.
- [14] I. Vasylytsov, C. Bak, Method for seamless unlock function for mobile applications, in: 2016 38th Annual International Conference of the IEEE Engineering in Medicine and Biology Society (EMBC), 2016, pp. 2614–2617.
755

- [15] R. M. Seepers, C. Strydis, I. Sourdis, C. I. D. Zeeuw, On using a von neumann extractor in heart-beat-based security, in: 2015 IEEE Trust-com/BigDataSE/ISPA, Vol. 1, 2015, pp. 491–498.
- 760 [16] L. González-Manzano, J. M. de Fuentes, P. Peris-Lopez, C. Camara, Encryption by heart (ebh)—using ecg for time-invariant symmetric key generation, *Future Generation Computer Systems* 77 (2017) 136 – 148.
- [17] D. K. Altop, A. Levi, V. Tuzcu, Deriving cryptographic keys from physiological signals, *Pervasive and Mobile Computing* 39 (2017) 65 – 79.
- 765 [18] I. Vasylytsov, S. Lee, Entropy extraction from bio-signals in healthcare iot, in: *IoTPTS*, 2015, pp. 11–17.
- [19] G. Zheng, G. Fang, R. Shankaran, M. Orgun, J. Zhou, L. Qiao, K. Saleem, Multiple ecg fiducial points based random binary sequence generation for securing wireless body area networks, *IEEE Journal of Biomedical and Health Informatics PP* (99) (2016) 1–1.
- 770 [20] R. M. Seepers, C. Strydis, P. Peris-Lopez, I. Sourdis, C. I. D. Zeeuw, Peak misdetection in heart-beat-based security: Characterization and tolerance, in: 2014 36th Annual International Conference of the IEEE Engineering in Medicine and Biology Society, 2014, pp. 5401–5405.
- 775 [21] W.-H. Lin, D. Wu, C. Li, H. Zhang, Y.-T. Zhang, Comparison of heart rate variability from ppg with that from ecg, in: *ICHI 2013*, 2014, pp. 213–215.
- [22] L. Yao, B. Liu, G. Wu, K. Yao, J. Wang, A biometric key establishment protocol for body area networks, *International Journal of Distributed Sensor Networks* 2011.
- 780 [23] R. M. Seepers, J. H. Weber, Z. Erkin, I. Sourdis, C. Strydis, Secure key-exchange protocol for implants using heartbeats, in: *Proceedings of the ACM International Conference on Computing Frontiers*, 2016, pp. 119–126.
- 785 [24] S.-D. Bao, L.-F. Shen, Y.-T. Zhang, A novel key distribution of body area networks for telemedicine, in: *IEEE International Workshop on Biomedical Circuits and Systems*, 2004., 2004, pp. 1–17.
- [25] S. Cherukuri, K. K. Venkatasubramanian, S. K. S. Gupta, Biosec: a biometric based approach for securing communication in wireless networks of biosensors implanted in the human body, in: *2003 International Conference on Parallel Processing Workshops*, 2003. *Proceedings.*, 2003, pp. 432–439.
- 790 [26] L. Ortiz-Martin, P. Picazo-Sanchez, P. Peris-Lopez, J. Tapiador, Heartbeats do not make good pseudo-random number generators: An analysis of the randomness of inter-pulse intervals, *Entropy* 20 (2).

- [27] F. Xu, Z. Qin, C. C. Tan, B. Wang, Q. Li, Imdguard: Securing implantable medical devices with the external wearable guardian, in: IEEE INFOCOM, 2011, pp. 1862–1870.
- [28] S. R. Moosavi, E. Nigussie, S. Virtanen, J. Isoaho, Cryptographic key generation using ecg signal, in: 2017 14th IEEE Annual Consumer Communications Networking Conference (CCNC), 2017, pp. 1024–1031.
- [29] S. M. R. Islam, D. Kwak, M. H. Kabir, M. Hossain, K. S. Kwak, The internet of things for health care: A comprehensive survey, *IEEE Access* 3 (2015) 678–708.
- [30] M. Ambigavathi, D. Sridharan, Energy efficient and load balanced priority queue algorithm for wireless body area network, *Future Generation Computer Systems* 88 (2018) 586 – 593.
- [31] A. L. Goldberger, L. A. N. Amaral, L. Glass, J. M. Hausdorff, P. C. Ivanov, R. G. Mark, J. E. Mietus, G. B. Moody, C.-K. Peng, H. E. Stanley, PhysioBank, PhysioToolkit, and PhysioNet: Components of a new research resource for complex physiologic signals, *Circulation* 101 (23) (2000 (June 13)) e215–e220.
- [32] N. Iyengar, C. Peng, R. Morin, A. L. Goldberger, L. A. Lipsitz, Age-related alterations in the fractal scaling of cardiac interbeat interval dynamics, *American Journal of Physiology-Regulatory, Integrative and Comparative Physiology* 271 (4) (1996) R1078–R1084.
- [33] T. Penzel, G. B. Moody, R. G. Mark, A. L. Goldberger, J. H. Peter, The apnea-ecg database, in: *Computers in cardiology 2000*, 2000, pp. 255–258.
- [34] M. GB, M. RG, A new method for detecting atrial fibrillation using r-r intervals, *Computers in Cardiology*.
- [35] G. Moody, A. Goldberger, S. McClennen, S. Swiryn, Predicting the onset of paroxysmal atrial fibrillation: the computers in cardiology challenge 2001, in: *Computers in Cardiology 2001. Vol.28 (Cat. No.01CH37287)*, 2001, pp. 113–116.
- [36] E. Institute, Aha database sample excluded record (2018).
URL <https://physionet.org/physiobank/database/ahadb/>
- [37] M. A. García-González, A. Argelagós-Palau, M. Fernández-Chimeno, J. Ramos-Castro, A comparison of heartbeat detectors for the seismocardiogram, in: *Computing in Cardiology Conference (CinC)*, 2013, 2013, pp. 461–464.
- [38] A. Taddei, G. Distante, M. Emdin, P. Pisani, G. Moody, C. Zeelenberg, C. Marchesi, The european st-t database: standard for evaluating systems for the analysis of st-t changes in ambulatory electrocardiography, *European heart journal* 13 (9) (1992) 1164–1172.

- [39] Physionet, Intracardiac atrial fibrillation database (2018).
URL <https://physionet.org/physiobank/database/iafdb/>
- 835 [40] Physionet, St.-petersburg institute of cardiological technics 12-lead arrhythmia database (2018).
URL <https://physionet.org/physiobank/database/incartdb/>
- [41] S. Petrutiu, A. V. Sahakian, S. Swiryn, Abrupt changes in fibrillatory wave characteristics at the termination of paroxysmal atrial fibrillation in humans, *Europace* 9 (7) (2007) 466–470.
- 840 [42] G. B. Moody, R. G. Mark, The impact of the mit-bih arrhythmia database, *Engineering in Medicine and Biology Magazine, IEEE* 20 (3) (2001) 45–50.
- [43] Physionet, The MIT-BIH Normal Sinus Rhythm Database (2018).
URL <https://physionet.org/physiobank/database/nsrdb/>
- 845 [44] G. B. Moody, W. Muldrow, R. G. Mark, A noise stress test for arrhythmia detectors, *Computers in cardiology* 11 (3) (1984) 381–384.
- [45] P. Laguna, R. Mark, A. Goldberg, G. Moody, Database for evaluation of algorithms for measurement of QT and other waveform intervals in the ECG, in: *Computers in Cardiology, Vol. 1997, 1997*, pp. 673 – 676.
- [46] S. D. Greenwald, The development and analysis of a ventricular fibrillation detector, Ph.D. thesis, Massachusetts Institute of Technology (1986).
850
- [47] P. Melillo, R. Izzo, A. Orrico, P. Scala, M. Attanasio, M. Mirra, N. De Luca, L. Pecchia, Automatic prediction of cardiovascular and cerebrovascular events using heart rate variability analysis, *PloS one* 10 (3) (2015) e0118504.
- [48] Y. Ichimaru, G. Moody, Development of the polysomnographic database on cd-rom, *Psychiatry and Clinical Neurosciences* 53 (2) (1999) 175–177.
855
- [49] T. P. . C. i. C. C. Moody GB, T-wave alternans. *computers in cardiology, Neurology* 35 (2008) 505–508.
- [50] S. D. Greenwald, The development and analysis of a ventricular fibrillation detector, Ph.D. thesis, Massachusetts Institute of Technology (1986).
- 860 [51] C. Vastarouchas, S. Kapoulea, C. Psychalinos, Ecg signal acquisition for the pan-tompkins algorithm using current-mirror filters, in: *IEEE International Conference on Electronics, Circuits and Systems, 2016*, pp. 317–320.
- [52] S. Peter, B. Pratap Reddy, F. Momtaz, T. Givargis, Design of secure ecg-based biometric authentication in body area sensor networks, *Sensors* 16 (4).
865
- [53] S. Pirbhulal, H. Zhang, W. Wu, S. C. Mukhopadhyay, Y. Zhang, Heartbeats based biometric random binary sequences generation to secure wireless body sensor networks, *IEEE Transactions on Biomedical Engineering* (2018) 1–1.

- 870 [54] R. Altawy, A. M. Youssef, Security tradeoffs in cyber physical systems: A case study survey on implantable medical devices, *IEEE Access*.
- [55] G. Chen, Are electroencephalogram (eeg) signals pseudo-random number generators?, *Journal of Computational and Applied Mathematics* 268 (2014) 1 – 4.
- 875 [56] B. Petchlert, H. Hasegawa, Using a low-cost electroencephalogram (eeg) directly as random number generator, in: *Advanced Applied Informatics (IIAIAAI)*, 2014 IIAI 3rd International Conference on, 2014, pp. 470–474.
- [57] J. Szczepanski, E. Wajnyrb, J. Amigó, M. V. Sanchez-Vives, M. Slater, Biometric random number generators, *Computers & Security* 23 (1) (2004) 880 77 – 84.
- [58] K. K. Venkatasubramanian, Venkatasubramanian, A. Banerjee, S. K. S. Gupta, Ekg-based key agreement in body sensor networks, in: *IEEE INFOCOM Workshops*, 2008, pp. 1–6.
- [59] A. Juels, M. Wattenberg, A fuzzy commitment scheme, in: *Conference on Computer and Communications Security*, 1999, pp. 28–36. 885
- [60] L. M. Dinca, G. Hancke, User-centric key entropy: Study of biometric key derivation subject to spoofing attacks, *Entropy* 19 (2).
- [61] H. Kang, Y. Hori, T. Katashita, M. Hagiwara, K. Iwamura, Performance analysis for puf data using fuzzy extractor, in: Y.-S. Jeong, Y.-H. Park, C.-H. R. Hsu, J. J. J. H. Park (Eds.), *Ubiquitous Information Technologies and Applications*, 2014, pp. 277–284. 890
- [62] N. Li, F. Guo, Y. Mu, W. Susilo, S. Nepal, Fuzzy extractors for biometric identification, in: *2017 IEEE 37th International Conference on Distributed Computing Systems (ICDCS)*, 2017, pp. 667–677.
- 895 [63] C. Herder, L. Ren, M. van Dijk, M. D. Yu, S. Devadas, Trapdoor computational fuzzy extractors and stateless cryptographically-secure physical unclonable functions, *IEEE Transactions on Dependable and Secure Computing* 14 (1) (2017) 65–82.
- [64] A. Schaller, T. Stanko, B. Škorić, S. Katzenbeisser, Eliminating leakage in reverse fuzzy extractors, *IEEE Transactions on Information Forensics and Security* 13 (4) (2018) 954–964. 900
- [65] X. Li, J. Liu, Q. Yao, J. Ma, Efficient and consistent key extraction based on received signal strength for vehicular ad hoc networks, *IEEE Access* 5 (2017) 5281–5291.
- 905 [66] Y. Dodis, L. Reyzin, A. Smith, Fuzzy extractors: How to generate strong keys from biometrics and other noisy data, in: *EUROCRYPT*, 2004, pp. 523–540.

- [67] I. Natgunanathan, A. Mehmood, Y. Xiang, G. Beliakov, J. Yearwood, Protection of privacy in biometric data, *IEEE Access* 4 (2016) 880–892.
- 910 [68] R. Alur, T. A. Henzinger, Logics and models of real time: A survey, in: *Real-Time: Theory in Practice*, REX Workshop, Vol. 600, 1991, pp. 74–106.
- [69] R. Alur, D. L. Dill, A theory of timed automata, *Theor. Comput. Sci.* 126 (2) (1994) 183–235.
- 915 [70] G. Behrmann, A. David, K. G. Larsen, J. Hakansson, P. Petterson, W. Yi, M. Hendriks, Uppaal 4.0, in: *Proceedings of the 3rd International Conference on the Quantitative Evaluation of Systems*, 2006, pp. 125–126.
- [71] M. Bozga, C. Daws, O. Maler, A. Olivero, S. Tripakis, S. Yovine, Kronos: A model-checking tool for real-time systems, in: *Computer Aided Verification*, Vol. 1427, 1998, pp. 546–550.
- 920 [72] R. Alur, T. A. Henzinger, Real-time logics: Complexity and expressiveness, *Inf. Comput.* 104 (1) (1993) 35–77.
- [73] M. P. Tulppo, T. Makikallio, T. Takala, T. Seppanen, H. V. Huikuri, Quantitative beat-to-beat analysis of heart rate dynamics during exercise, *American journal of physiology-heart and circulatory physiology* 271 (1) (1996) H244–H252.
- 925 [74] A. Calleja, P. Peris-Lopez, J. E. Tapiador, Electrical heart signals can be monitored from the moon: Security implications for ipi-based protocols, in: R. N. Akram, S. Jajodia (Eds.), *Information Security Theory and Practice*, 2015, pp. 36–51.
- 930 [75] C. Camara, P. Peris-Lopez, L. Gonzalez-Manzano, J. Tapiador, Real-time electrocardiogram streams for continuous authentication, *Applied Soft Computing* 68 (2018) 784 – 794.
- [76] J. Pan, W. J. Tompkins, A real-time qrs detection algorithm, *IEEE Transactions on Biomedical Engineering BME-32* (3) (1985) 230–236.
- 935 [77] Y. S. Han, BCH codes, in: *Graduate Institute of Communication Engineering*, National Taipei University, 2016.
- [78] G. Zheng, G. Fang, R. Shankaran, M. A. Orgun, Encryption for implantable medical devices using modified one-time pads, *IEEE Access* 3 (2015) 825–836.
- 940 [79] T. Bai, J. Lin, G. Li, H. Wang, P. Ran, Z. Li, D. Li, Y. Pang, W. Wu, G. Jeon, A lightweight method of data encryption in bans using electrocardiogram signal, *Future Generation Computer Systems* 92 (2019) 800 – 811.

- 945 [80] G. Zheng, G. Fang, M. A. Orgun, R. Shankaran, A comparison of key distribution schemes using fuzzy commitment and fuzzy vault within wireless body area networks, in: PIMRC, 2015, pp. 2120–2125.
- [81] A. Sammoud, O. Hamdi, M. A. Chalouf, A. Bouallegue, A new protocol for an efficient and green biometric-based security key establishment in wban's, 950 in: IWCMC, 2018, pp. 762–767.
- [82] Z. Zhang, H. Wang, A. V. Vasilakos, H. Fang, Ecg-cryptography and authentication in body area networks, *IEEE Transactions on Information Technology in Biomedicine* 16 (6) (2012) 1070–1078.
- [83] P. Tuyls, B. Skoric, T. Kevenaar, Security with Noisy Data: Private Biometrics, Secure Key Storage and Anti-Counterfeiting, Springer-Verlag, 955 2007.
- [84] W. Wu, S. Pirbhulal, A. K. Sangaiah, S. C. Mukhopadhyay, G. Li, Optimization of signal quality over comfortability of textile electrodes for eeg monitoring in fog computing based medical applications, *Future Generation Computer Systems* 86 (2018) 515 – 526. 960
- [85] A. Carman, Withings' new smartwatch has an eeg sensor to compete with the apple watch (2019).
URL <https://goo.gl/tbrmQz>
- [86] C. Carreiras, A. Lourenço, A. Fred, R. Ferreira, Eeg signals for biometric applications – are we there yet?, in: Proceedings of the 11th International Conference on Informatics in Control, Automation and Robotics, SciTePress, 2014, pp. 765–772. 965
- [87] B. Secure, Eeg biometrics for the connected car (white paper) (2018).
URL <https://goo.gl/mXC8xG>
- 970 [88] E. K. Zaghoulani, A. Jemai, A. Benzina, R. Attia, Elpa: A new key agreement scheme based on linear prediction of eeg features for wban, in: 2015 23rd European Signal Processing Conference (EUSIPCO), 2015, pp. 81–85.
- [89] P. Bagade, A. Banerjee, J. Milazzo, S. K. S. Gupta, Protect your bsn: No handshakes, just namaste!, in: 2013 IEEE International Conference on Body Sensor Networks, 2013, pp. 1–6. 975